

User's Guide



Hammerfall[®] DSP System

HDSPe MADI

DVD

24 Bit / 192 kHz

ready

TotalMix[™]



SyncAlign[™]

ZLM[™]

SyncCheck[™]

SteadyClock[™]

PCI Express Digital I/O Card
64 Channels MADI Interface
24 Bit / 192 kHz Digital Audio
Stereo Analog Monitoring
128 x 64 Matrix Router
2 x MIDI I/O
MIDI embedded in MADI

▶ **General**

1	Introduction	6
2	Package Contents	6
3	System Requirements	6
4	Brief Description and Characteristics	6
5	Hardware Installation	7
6	Hardware – Connectors	
6.1	External Connectors	7
6.2	Internal Connectors.....	8
7	Accessories	8
8	Warranty	8
9	Appendix	9

▶ **Driver Installation and Operation - Windows**

10	Driver and Firmware	
10.1	Driver Installation	12
10.2	Driver Update	12
10.3	De-Installing the Drivers.....	12
10.4	Firmware Update.....	13
11	Configuring the HDSPe MADI	
11.1	Settings Dialog	14
11.2	Settings Dialog – Pitch	16
11.3	Clock Modes – Synchronization.....	17
12	Operation and Usage	
12.1	Playback.....	18
12.2	DVD Playback (AC-3 / DTS)	19
12.3	Notes on WDM	20
12.4	Multi-client Operation	20
12.5	Digital Recording	21
13	Operation under ASIO	
13.1	General	22
13.2	Known Problems	22
14	Using multiple HDSPe MADI	23
15	DIGICheck Windows	23
16	Hotline – Troubleshooting	24

▶ **Driver Installation and Operation - Mac OS X**

17	Driver and Flash Update	
17.1	Driver Installation	26
17.2	Driver Update	26
17.3	Firmware Update	26
18	Configuring the HDSPe MADI	
18.1	Settings Dialog	27
18.2	Clock Modes – Synchronization	29
19	Mac OS X FAQ	
19.1	Round about Driver Installation	30
19.2	MIDI doesn't work	30
19.3	Supported Sample Rates	30
19.4	Repairing Disk Permissions	30
19.5	Various Information	31
20	Using more than one HDSPe System	31
21	DIGICheck Mac	32
22	Hotline – Troubleshooting	32

▶ **Connections and TotalMix**

23	Connections	
23.1	Headphones	34
23.2	MADI I/Os	34
23.3	MIDI	35
24	Word Clock	
24.1	Word Clock Input and Output	35
24.2	Technical Description and Background	36
24.3	Cables and Termination	37
24.4	General Operation	38
25	TotalMix: Routing and Monitoring	
25.1	Overview	39
25.2	The User Interface	40
25.3	Elements of a Channel	42
25.4	Tour de TotalMix	42
25.5	Submix View	44
25.6	Mute and Solo	44
25.7	Quick Access Panel	45
25.8	Presets	45
25.9	Monitor Panel	47
25.10	Preferences	47
25.11	Editing the Names	48
25.12	Hotkeys	49
25.13	Menu Options	50
25.14	Fader Groups	50
25.15	Level Meter	51

26	TotalMix: The Matrix	
26.1	Overview	52
26.2	Elements of the Matrix View	52
26.3	Usage	52
26.4	Advantages of the Matrix	53
27	TotalMix Super-Features	
27.1	ASIO Direct Monitoring (Windows only)	53
27.2	Selection and Group based Operation	54
27.3	Copy Routings to other Channels	54
27.4	Delete Routings.....	54
27.5	Recording a Subgroup (Loopback).....	55
27.6	Using external Effects Devices	56
27.7	MS Processing	57
28	TotalMix MIDI Remote Control	
28.1	Overview	58
28.2	Mapping	58
28.3	Setup	59
28.4	Operation	59
28.5	Simple MIDI Control	60
28.6	Loopback Detection	61

▶ **Technical Reference**

29	Technical Specifications	
29.1	Inputs	64
29.2	Outputs.....	64
29.3	Digital	65
29.4	MIDI.....	65
30	Technical Background	
30.1	MADI Basics.....	66
30.2	Lock and SyncCheck	67
30.3	Latency and Monitoring.....	68
30.4	DS – Double Speed	69
30.5	QS – Quad Speed.....	70
30.6	SteadyClock	71
30.7	Terminology	72

User's Guide



HDSPe MADI

▶ General

1. Introduction

Thank you for choosing the HDSPe MADI. This unique audio system is capable of transferring digital audio data directly into a computer, from any device equipped with a MADI interface. Installation is simple, even for the inexperienced user, thanks to the latest Plug and Play technology. The numerous unique features and well thought-out configuration dialog puts the Hammerfall DSP MADI at the very top of the range of digital audio interface cards.

The package contains drivers for Windows (XP, Vista, 7, 8) and Mac OS X x86 (Intel).

Our high-performance philosophy guarantees maximum system performance by executing as many functions as possible not in the driver (i.e. the CPU), but directly within the audio hardware.

2. Package Contents

Please check that your HDSPe MADI package contains each of the following:

- HDSPe MADI PCI card
- HDSPe MADI expansion board
- Quick Info guide
- RME Driver CD
- MIDI breakout cable
- Expansion Board ribbon cable (14-conductor)

3. System Requirements

- Windows XP or up, Mac OS X Intel (10.5 or up)
- PCI Express Interface: a free PCI Express slot, 1 lane, version 1.1

4. Brief Description and Characteristics

- All settings can be changed in real-time
- 8 available buffer sizes/latencies: 0.7 / 1.5 / 3 / 6 / 12 / 23 / 46 / 93 ms
- 32 channels 96 kHz/24 bit record/playback
- 16 channels 192 kHz/24 bit record/playback
- Automatic and intelligent master/slave clock control
- Word clock input and output
- TotalMix for latency-free submixes and perfect ASIO Direct Monitoring
- SyncAlign guarantees sample aligned and never swapping channels
- SyncCheck tests and reports the synchronization status of input signals
- 2 x MIDI I/O, 32 channels high-speed MIDI
- DIGICheck DSP: Level meter in hardware, peak- and RMS calculation
- TotalMix: 8192 channel mixer with 42 bit internal resolution
- SteadyClock: Jitter-immune, super-stable digital clock
- Quick Boot technology for immediate loading of the hardware settings
- Optional Time Code module (TCO) for external Video-/SMPTE synchronization

5. Hardware Installation



Before installing the PCI Express card, please make sure the computer is switched off and the power cable is disconnected from mains supply. Inserting or removing the card while the computer is in operation can cause irreparable damage to both motherboard and card!

1. Disconnect the power cord and all other cables from the computer.
2. Remove the computer's housing. Further information on how to do this can be obtained from your computer's instruction manual.
3. Important: Before removing the HDSPe MADI from its protective bag, discharge any static in your body by touching the metal chassis of the PC.
4. Prior to installation: Connect the HDSPe MADI card to the Expansion Board using the supplied flat ribbon cable.
5. Insert the HDSPe MADI firmly into a free PCI Express slot, press and fasten the screw.
6. Insert the Expansion Board and fasten the screw.
7. Replace the computer's housing.
8. Reconnect all cables including the power cord.

6. Hardware - Connectors

6.1 External Connectors

The bracket of the main board has two **MADI** interfaces, **optical** and **coaxial** input and output each, a **MADI error LED** and the **analog stereo** output.

Identical signals are available at both the optical and the coaxial output.

Therefore two devices can be connected, i.e. using the HDSPe MADI as a splitter (distribution 1 to 2).

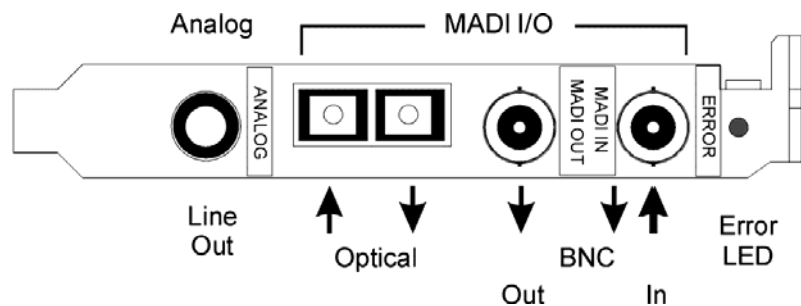

The Expansion Board's bracket has the **word clock** input and output. Next to the input BNC socket, a **green** LED displays the word clock input's **LOCK** state. Between the BNC sockets, **75 Ohm** word clock termination can be activated and verified by a **yellow** LED.

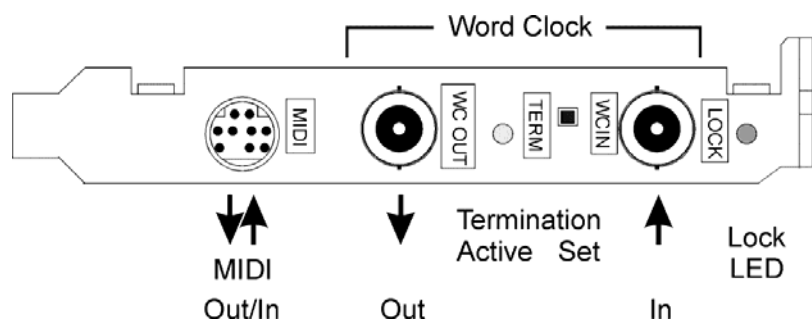

The included breakout cable is connected to the **9-pin Mini-DIN** connector and provides **two MIDI** inputs and outputs via four **5-pin DIN** connectors.

Note: If neither word clock I/O nor MIDI I/O is required, it is not necessary to install the Expansion Board at all.

6.2 Internal Connectors

X402

15-pin connector for the included HDSPe MADi Expansion Board.

X403

10-pin connector for a connection of the Time Code Option (TCO).

X200

No function. Used to program the card in the factory.

X400 Sync In

Internal word clock input for synchronization of multiple cards via SYNC OUT. Supported since firmware version 17.

X401 Sync Out

This 3-pin connector carries an internal word clock signal. It can be used to synchronize multiple cards with sample accuracy, and without the need for an external connection. The card where SYNC OUT is used is Master, the one with SYNC IN is Slave. In the Settings dialog the Slave has to be set to *Sync In* under *Pref. Sync Ref*, the Clock Mode must be set to *AutoSync*. Supported since firmware version 17.

7. Accessories

RME offers several optional components. Additionally parts of the HDSPE MADi, like the special breakout cables, are available separately.

Part Number	Description
BOHDSP9652	MIDI breakout cable
VKHDSP9652	14-conductor flat ribbon cable
ONK0100	MADi Optical Network Cable, 3.3 ft (1 m)
ONKD0300	MADi Optical Network Cable, 10 ft (3 m)
ONKD0600	MADi Optical Network Cable, 20 ft (6 m)
ONKD1000	MADi Optical Network Cable, 33 ft (10 m)
ONKD2000	MADi Optical Network Cable, 66 ft (20 m)
ONKD5000	MADi Optical Network Cable, 165 ft (50 m)

8. Warranty

Each individual HDSPe undergoes comprehensive quality control and a complete test at IMM before shipping. The usage of high grade components should guarantee a long and trouble-free operation of the unit.

If you suspect that your product is faulty, please contact your local retailer.

Audio AG grants a limited manufacturer warranty of 6 months from the day of invoice showing the date of sale. The length of the warranty period is different per country. Please contact your local distributor for extended warranty information and service. Note that each country may have regional specific warranty implications.

In any case warranty does not cover damage caused by improper installation or maltreatment - replacement or repair in such cases can only be carried out at the owner's expense.

No warranty service is provided when the product is not returned to the local distributor in the region where the product had been originally shipped.

Audio AG does not accept claims for damages of any kind, especially consequential damage. Liability is limited to the value of the Hammerfall DSP. The general terms of business drawn up by Audio AG apply at all times.

9. Appendix

RME news, driver updates and further product information are available on our website:

<http://www.rme-audio.com>

Distributor:

Audio AG, Am Pfanderling 60, D-85778 Haimhausen, Tel.: (49) 08133 / 91810

Manufacturer:

IMM Elektronik GmbH, Leipziger Strasse 32, D-09648 Mittweida

Trademarks

All trademarks, registered or otherwise, are the property of their respective owners. RME, DIGICheck and Hammerfall are registered trademarks of RME Intelligent Audio Solutions. HDSP MADI, HDSP AES-32, TMS, DIGI96, SyncAlign, ZLM, SyncCheck and TotalMix are trademarks of RME Intelligent Audio Solutions. Alesis and ADAT are registered trademarks of Alesis Corp. ADAT optical is a trademark of Alesis Corp. Microsoft, Windows 2000, Windows XP, Windows Vista and Windows 7 are registered trademarks or trademarks of Microsoft Corp. Steinberg, Cubase and VST are registered trademarks of Steinberg Media Technologies GmbH. ASIO is a trademark of Steinberg Media Technologies GmbH.

Copyright © Matthias Carstens, 02/2012. Version 1.4

Current driver version: W2k/XP: 3.27, Mac OS X Intel: 3.01

Although the contents of this User's Guide have been thoroughly checked for errors, RME can not guarantee that it is correct throughout. RME does not accept responsibility for any misleading or incorrect information within this guide. Lending or copying any part of the guide or the RME Driver CD, or any commercial exploitation of these media without express written permission from RME Intelligent Audio Solutions is prohibited. RME reserves the right to change specifications at any time without notice.

CE / FCC Compliance

CE

This device has been tested and found to comply with the limits of the European Council Directive on the approximation of the laws of the member states relating to electromagnetic compatibility according to RL2004/108/EG.

FCC

This equipment has been tested and found to comply with the limits for a Class B digital device, pursuant to Part 15 of the FCC Rules. These limits are designed to provide reasonable protection against harmful interference in a residential installation. This equipment generates, uses, and can radiate radio frequency energy and, if not installed and used in accordance with the instructions, may cause harmful interference to radio communications. However, there is no guarantee that interference will not occur in a particular installation. If this equipment does cause harmful interference to radio or television reception, which can be determined by turning the equipment off and on, the user is encouraged to try to correct the interference by one or more of the following measures:

- Reorient or relocate the receiving antenna.
- Increase the separation between the equipment and receiver.
- Connect the equipment into an outlet on a circuit different from that to which the receiver is connected.
- Consult the dealer or an experienced radio/TV technician for help.

RoHS

This product has been soldered lead-free and fulfils the requirements of the RoHS directive.

ISO 9001

This product has been manufactured under ISO 9001 quality management. The manufacturer, IMM Elektronik GmbH, is also certified for ISO 14001 (Environment) and ISO 13485 (medical devices).

Note on Disposal

According to the guide line RL2002/96/EG (WEEE – Directive on Waste Electrical and Electronic Equipment), valid for all european countries, this product has to be recycled at the end of its lifetime.

In case a disposal of electronic waste is not possible, the recycling can also be done by IMM Elektronik GmbH, the manufacturer of the HDSPe MADI.

For this the device has to be sent **free to the door** to:

IMM Elektronik GmbH
Leipziger Straße 32
D-09648 Mittweida
Germany



Shipments not prepaid will be rejected and returned on the original sender's costs.

User's Guide



HDSPe MADI

- ▶ **Driver Installation and Operation - Windows**

10. Driver and Firmware

10.1 Driver Installation

After the HDSPe MADI has been installed correctly (see 5. Hardware Installation), and the computer has been switched on, Windows will recognize the new hardware component and start its 'Hardware Wizard'. Insert the RME Driver CD into your CD-ROM drive, and follow further instructions which appear on your computer screen. The driver files are located in the directory **WDM** on the RME Driver CD.

Windows now installs the driver of the HDSP system and registers it as a new audio device in the system. After a reboot, the symbols of TotalMix and Settings dialog will appear in the task bar.



In case the Hardware Wizard does not show up automatically after installation of the card, do not attempt to install the drivers manually! An installation of drivers for non-recognized hardware will cause a blue screen when booting Windows!

In **Windows 7** Microsoft removed the automatic start of the Driver Software Update dialog. Therefore this dialog has to be started manually after the failed driver installation. Hit the Win key, type 'Device Manager', start the Device Manager by selecting it from the list and hit Enter.

The device is shown with a yellow warning symbol. Usually it is already found in the correct category, Sound, Video and Game Controller (Plug & Play detects a multimedia device). Right click on the device and select 'Update Driver Software' from the context menu.

The dialog *Update Driver Software* appears. Now follow the instructions given below.

10.2 Driver Update

When facing problems with the automatic driver update, the user-driven way of driver installation will work.

Under *>Control Panel /System /Device Manager /Sound, Video and Game Controllers /RME Hammerfall DSP MADI /Properties /Driver* you'll find the 'Update Driver' button.

XP: Select '**Install from a list or specific location (advanced)**', click '**Next**', select '**Don't search I will choose the driver to install**', click '**Next**', then '**Have Disk**'. Now point to the driver update's directory.

Vista/7: Select '**Browse my computer for driver software**', then '**Let me pick from a list of device drivers from my computer**', then '**Have Disk**'. Now point to the driver update's directory.

This method also allows for the installation of older drivers than the currently installed ones.

10.3 De-Installing the Drivers

A de-installation of the HDSPe driver files is not necessary – and not supported by Windows anyway. Thanks to full Plug & Play support, the driver files will not be loaded after the hardware has been removed. If desired these files can then be deleted manually.

Unfortunately Windows Plug & Play methods do not cover the additional autorun entries of TotalMix, the Settings dialog, and the registration of the ASIO driver. Those entries can be removed from the registry through a software de-installation request. This request can be found (like all de-installation entries) in *Control Panel, Software*. Click on the entry 'RME Hammerfall DSP (WDM)'.

10.4 Firmware Update

The Flash Update Tool updates the HDSPe MADI to the latest firmware version. It requires an already installed driver.

Start the program **pcie_fut.exe**. The Flash Update Tool displays the current revision of the HDSPe MADI, and whether it needs an update or not. If so, then please press the 'Update' button. A progress bar will indicate when the flash process is finished. The bar moves slowly first (program), then faster (verify).

If more than one interface card is installed, all cards can be flashed by changing to the next tab and repeating the process.

After the update the PCI Express card needs to be reset. This is done by powering down and shutting off the PC. A warm boot is not enough!

When the update fails (status: failure), the card's second BIOS will be used from the next cold boot on (Secure BIOS Technology). Therefore the card stays fully functional. The flash process should then be tried again on a different computer.

11. Configuring the HDSPe MADi

11.1 Settings Dialog

Configuration of the HDSPe MADi is done via its own settings dialog. The panel 'Settings' can be opened:

- by clicking on the hammer symbol in the Task Bar's notification area

The mixer of the Hammerfall DSP System (TotalMix) can be opened:



- by clicking on the mixer icon in the Task Bar's notification area

The hardware of the HDSP system offers a number of helpful, well thought-of practical functions and options which affect how the card operates - it can be configured to suit many different requirements. The following is available in the 'Settings' dialog:

- Input selection
- Configuration of digital I/Os
- Synchronization behaviour
- State of input and output
- Current sample rate
- Latency

Any changes made in the Settings dialog are applied immediately - confirmation (e.g. by clicking on OK or exiting the dialog) is not required.

However, settings should not be changed during playback or record if it can be avoided, as this can cause unwanted noises.

Also, please note that even in 'Stop' mode, several programs keep the recording and playback devices open, which means that any new settings might not be applied immediately.

The status displays at the bottom of the dialog box give the user precise information about the current status of the system, and the status of all digital signals.

The tab About includes information about the current driver and firmware version of the HDSPe MADi.

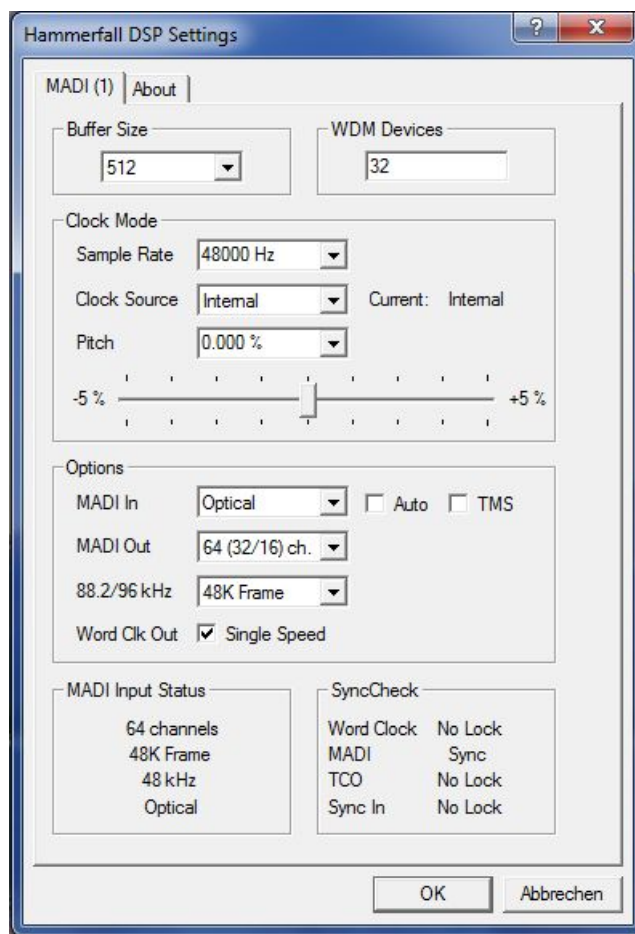

Buffer Size

The setting *Buffer Size* determines the latency between incoming and outgoing ASIO and WDM data, as well as affecting system stability (see chapter 13.1).

WDM Devices

Not before Vista the OS had been capable to handle more than 32 WDM stereo devices. Therefore under W2k/XP it often makes sense to intentionally limit their number.

Clock Mode

Sample Rate

Sets the currently used sample rate. Offers a central and comfortable way of configuring the sample rate of all WDM devices to the same value, as since Vista the audio software is no longer allowed to set the sample rate. However, an ASIO program can still set the sample rate by itself.

During record/playback the selection is greyed out, so no change is possible.

Clock Source

The unit can be configured to use its own clock (Internal = Master), or one of the input signals (Word, MADI, TCO, Sync In). If the selected source isn't available (No Lock), the unit will change to the next available one (this behaviour is called AutoSync). If none is available then the internal clock is used. The current clock source is displayed as *Current*.

Pitch

More information on Pitch is available in chapter 11.2.

Options

MADI In

Defines the input for the MADI signal. 'Optical' relates to the optical input, 'Coaxial' to the BNC socket.

TMS activates the transmission of Channel Status data and Track Marker information from the MADI input signal.

Auto activates redundancy operation. If the current input signal fails, the other input will be used immediately, provided a valid signal is found there. *Input* also works as automatic input selection, in case only optical *or* coaxial is present as input signal.

MADI Out

Defines the format of the MADI output signal. MADI can be a 56 or 64 channel signal.

88.2/96 kHz

Sample rates higher than 48 kHz can be transmitted using the normal 48K Frame, or using a native 96K Frame at the card's output.

Word Clock Out

The word clock output signal usually equals the current sample rate. Selecting *Single Speed* causes the output signal to always stay within the range of 32 kHz to 48 kHz. So at 96 kHz and 192 kHz sample rate, the output word clock is 48 kHz.

MADI Input Status

Displays the state of the current input signal:

- Channel format (64 or 56 channels)
- Frame format (48K or 96K)
- Sample rate (measured)
- Active input (optical or coaxial)

Sync Check

RME's exclusive **SyncCheck** technology provides an easy to use check and display of the current clock status. The SyncCheck field indicates whether no signal (No Lock), a valid signal (Lock) or a valid *and* synchronous signal (Sync) is present at each of the digital clock source inputs.

About

This tab includes information about the driver and the card's firmware version.

Lock Registry uses a password to prevent changes of the settings stored in the registry. All settings are still changeable temporarily. As the settings are always loaded from the registry when starting the computer, this method provides an easy way to define a specific initial state of the HDSP system.

11.2 Settings Dialog - Pitch

Usually soundcards and audio interfaces generate their internal clock (master mode) by a quartz. Therefore the internal clock can be set to 44.1 kHz or 48 kHz, but not to a value in between. SteadyClock, RME's sensational Low Jitter Clock System, is based on a Direct Digital Synthesizer (DDS). This superior circuitry can generate nearly any frequency with highest precision.

DDS has been implemented into the HDSPe MADI with regard to the needs of professional video applications, as well as to maximum flexibility. The section Pitch includes both a list of typical video frequencies (so called pull up/pull down at 0.1% and 4%) and a fader to freely change the basic sample rate in steps of 1 Hz (!) over a range of +/- 5%.

 *The Pitch function requires the HDSPe MADI to be in clock mode Master! The frequency setting will only be applied to this one specific card!*

 *Changing the sample rate during record/playback often results in a loss of audio, or brings up warning messages of the audio software. Therefore the desired sample rate should be set at least coarsely before starting the software.*

Coarse

Coarse modification in steps of 50 Hz is done by clicking with the mouse to the left and right of the fader knob.

Fine

Fine modification in steps of 1 Hz is done by using the left/right cursor keys.

Reset

Ctrl key plus left mouse click.

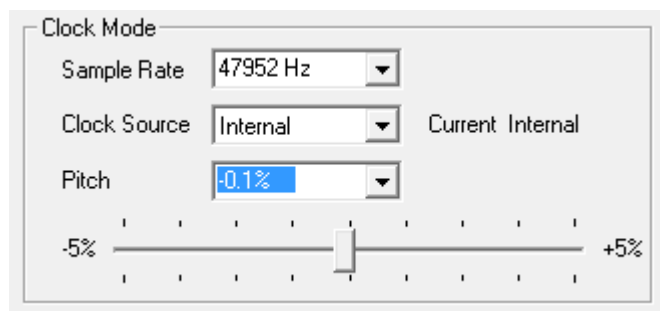

Application examples

Pitch allows for a simultaneous change of speed and tune during record and playback. From alignment to other sources up to creative effects – everything is possible.

Pitch enables you to intentionally de-tune the complete DAW. This way, the DAW can match instruments which have a wrong or unchangeable tuning.

Pitch allows for the change of the sample rate of all WDM devices at the same time. Since Vista this is no longer possible via the audio program, thus requires a manual reconfiguration of all WDM devices. Changing the sample rate from the Settings dialog solves this problem.

11.3 Clock Modes - Synchronisation

In the digital world, all devices must be either Master (clock source) or Slave (clock receiver). Whenever several devices are linked within a system, there must always be a single master clock.



A digital system can only have one master! If the card's clock mode is set to 'Master', all other devices must be set to 'Slave'.

The HDSPe MADI utilizes a very user-friendly, intelligent clock control, called **AutoSync**. In AutoSync mode, the system constantly scans the digital input for a valid signal. If any valid signal is found, the card switches from the internal quartz (*Clock Mode* – Current Internal) to a clock extracted from the input signal (*Clock Mode* – Current MADI, Word, TCO or Sync In). The difference to a usual slave mode is that whenever the clock reference fails, the system will automatically use its internal clock and operate in clock mode Master.

AutoSync guarantees that normal record and record-while-play will always work correctly. In certain cases however, AutoSync may cause feedback in the digital carrier, so synchronization breaks down. To remedy this, switch the HDSP's clock mode to 'Master'.

RME's exclusive **SyncCheck** technology enables an easy to use check and display of the current clock status. *SyncCheck* indicates whether there is a valid signal (Lock, No Lock) for each input (Word, MADI, TCO, Sync In), or if there is a valid *and* synchronous signal (Sync). In the field *Clock Mode* the clock reference is shown. See chapter 30.2.

Via *Clock Source* a preferred input can be defined. As long as the card sees a valid signal there, this input will be designated as the sync source, otherwise the other inputs will be scanned in turn. If none of the inputs are receiving a valid signal, the card automatically switches clock mode to 'Master'.

Under WDM the card will (has to) set the sample rate. Therefore the error shown to the right can occur. A stable signal with a sample rate of 32 kHz is detected at the Word Clock input (Sync), but Windows audio had been set to 44100 Hz before. The red colour of the text label signals the error condition, and prompts the user to set 32000 Hz manually as sample rate.

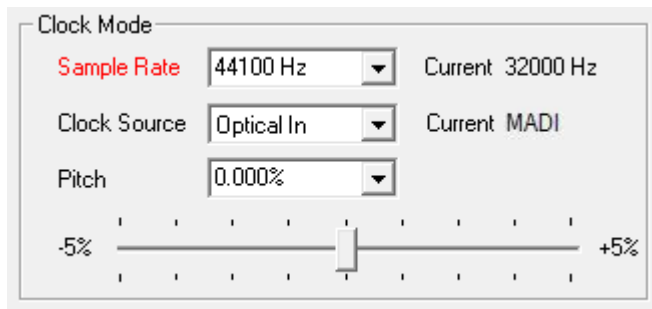

Under ASIO the audio software sets the sample rate, so that such an error will usually not happen – but it can too. In slave mode the external sample rate has priority. Feeding 44.1 kHz will prevent the ASIO software to set 48 kHz – obviously, as the only way to do so would be to enter a different clock mode (Master/Internal).

In practice, SyncCheck provides the user with an easy way of checking whether all digital devices connected to the system are properly configured. With SyncCheck, finally anyone can master this common source of error, previously one of the most complex issues in the digital studio world.

12. Operation and Usage

12.1 Playback

The HDSP system can play back audio data in supported formats only (sample rate, bit resolution). Otherwise an error message appears (for example at 22 kHz and 8 bit).

In the audio application being used, HDSP must be selected as output device. This can often be found in the *Options*, *Preferences* or *Settings* menus under *Playback Device*, *Audio Devices*, *Audio* etc.

We strongly recommend switching off all system sounds (via >*Control Panel /Sounds*<). Also HDSP should not be the *Preferred Device* for playback, as this could cause loss of synchronization and unwanted noises. If you feel you cannot do without system sounds, you should use on-board sound or any cheap sound card and select this one as *Preferred Device* in >*Control Panel /Multimedia /Audio*< or >*Control Panel /Sound /Playback*<.

The screenshot to the right shows a typical configuration dialog as displayed by a (stereo) wave editor. After selecting one of the 32 playback devices, audio data is sent to the according audio channels.

Increasing the number and/or size of audio buffers may prevent the audio signal from breaking up, but also increases latency i.e. output is delayed. For synchronized playback of audio and MIDI (or similar), be sure to activate the checkbox 'Get position from audio driver'.

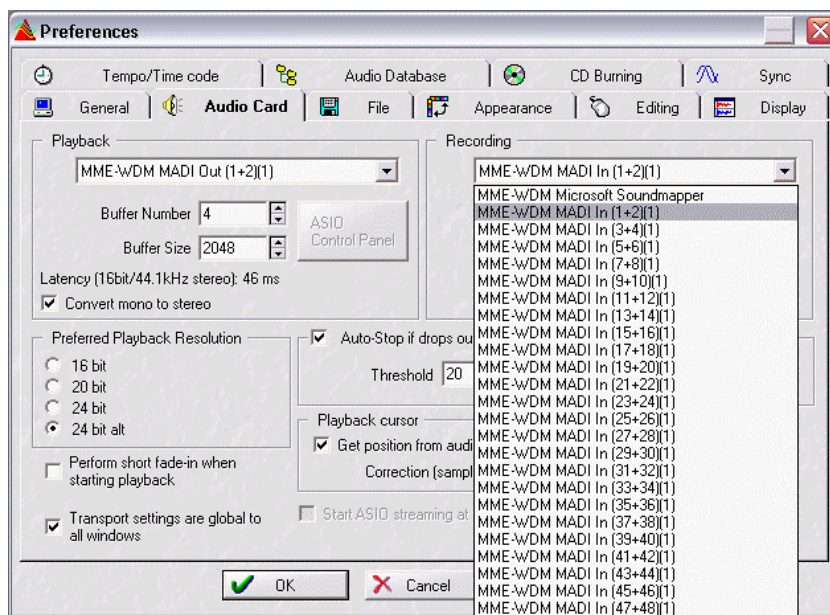

The HDSPe MADI allows sample rates of up to 192 kHz via MADI. In this mode, only channels 1 to 16 are available.

Note on Windows Vista/7:

Since Vista the audio application can no longer control the sample rate under WDM. Instead the user has to work himself through numerous settings (up to 32 with a MADI card!), and to set the sample rate to the exact same value per stereo device.

Therefore the driver of the HDSPe MADI includes a workaround: the sample rate can be set globally for all WDM devices within the Settings dialog, see chapter 11.1.

12.2 DVD-Playback (AC-3/DTS)

AC-3 / DTS

When using popular DVD software players like *WinDVD* and *PowerDVD*, their audio data stream can be sent to any AC-3/DTS capable receiver via the HDSPe MADI. For this to work an output wave device has to be selected in *>Control Panel/ Sounds and Multimedia/ Audio<* or *>Control Panel/ Sound/Playback<*. Also check 'use preferred device only'.

The DVD software's audio properties now show the options 'SPDIF Out' or similar. When selecting these, the software will transfer the non-decoded digital multichannel data stream to the HDSPe. Naturally a successful decoding also requires a MADI to AES converter like the **RME ADI-642**, converting the playback signals to stereo AES3 or SPDIF.

Note: This 'SPDIF' signal sounds like chopped noise at highest level. The first 2 channels (Loudspeaker) do not support digital AC-3/DTS playback.

Multichannel

PowerDVD and WinDVD can also operate as software decoder, sending a DVD's multichannel data stream directly to the outputs of the HDSPe MADI. For this to work select the WDM playback device 'Loudspeaker' of the HDSP MADI in

XP: *>Control Panel/ Sounds and Multimedia/ Audio<*, and 'Use only default devices' has to be checked. Additionally the loudspeaker setup, found under *>Volume/ Speaker Settings/ Advanced<* has to be changed from *Stereo* to *5.1 Surround*.

Vista/7: *>Control Panel/ Sound/ Playback <* as 'Standard'. Additionally the loudspeaker setup, found under *>Configuration<*, has to be changed from *Stereo* to *5.1 Surround*.

PowerDVD's and WinDVD's audio properties now list several multichannel modes. If one of these is selected, the software sends the decoded analog multichannel data to the HDSPe MADI. TotalMix can then be used to play back via any desired output channels.

The typical channel assignment for surround playback is:

- 1 - Left
- 2 - Right
- 3 - Center
- 4 - LFE (Low Frequency Effects)
- 5 - SL (Surround Left)
- 6 - SR (Surround Right)

Note 1: Setting the card to be used as system playback device is against common sense, as professional cards are not specialized to play back system sounds, and shouldn't be disturbed by system events. To prevent this be sure to re-assign this setting after usage or disable any system sounds (tab *Sounds*, scheme 'No audio').

Note 2: The DVD player will be synced backwards from the HDSPe card. So when using Auto-Sync and/or word clock, the playback speed and pitch follows the incoming clock signal.

12.3 Notes on WDM

The driver offers a WDM streaming device per stereo pair, like **HDSP MADI (1+2)**. WDM streaming is Microsoft's current driver and audio system. WDM streaming is hardly usable for professional music purposes, as all data is processed by the Kernel Mixer, causing a latency of at least 30 ms. Additionally, WDM can perform sample rate conversions unnoticed, cause offsets between record and playback data, block channels unintentionally and much more.

Several programs do not offer any direct device selection. Instead they use the *playback device* selected in Windows under

XP: <Control Panel/ Sounds and Multimedia/ Audio>

Vista/7: <Control Panel/ Sound/ Playback>

The program *Sonar* from Cakewalk is unique in many ways. Sonar uses the so called **WDM Kernel Streaming**, bypassing the WDM mixer, thus achieves a similar performance to ASIO.

Because of the driver's multichannel streaming ability Sonar not only finds the stereo device mentioned above, but also the 8-channel interleaved devices, and adds the channel number at the end:

HDSP MADI (1+2) is the first stereo device

HDSP MADI (3+4) is the next stereo device

HDSP MADI (1+2) 3/4 are the channels 3/4 of the first 8-channel interleaved device.

We recommend to not use these interleaved devices. Also note that it is not possible to use one stereo channel twice (the basic and the interleaved one), even with different applications.

Multi-Channel using WDM

The WDM Streaming device *Loudspeaker* (MADI Out 1+2) of the RME driver can operate as usual stereo device, or as up to 8-channel device.

An 8-channel playback using the Windows Media Player requires the speaker setup *7.1 Surround*. Configure as follows:

XP: >Control Panel /Sounds and Multimedia /Audio /Volume /Speaker Settings /Advanced <

Vista/7: >Control Panel /Sound /Playback /Loudspeaker /Configure <

12.4 Multi-client Operation

RME audio interfaces support multi-client operation. Several programs can be used at the same time. The formats ASIO and WDM can even be used on the same playback channels simultaneously. As WDM uses a real-time sample rate conversion (ASIO does not), all active ASIO software has to use the same sample rate.

However, a better overview is maintained by using the channels exclusively. This is no limitation at all, because TotalMix allows for any output routing, and therefore a playback of multiple software on the same hardware outputs.

Inputs can be used from an unlimited number of WDM and ASIO software at the same time, as the driver simply sends the data to all applications simultaneously.

RME's sophisticated tool *DIGICheck* is an exception to this rule. It operates like an ASIO host, using a special technique to access playback channels directly. Therefore DIGICheck is able to analyse and display playback data from any software, no matter which format it uses.

12.5 Digital Recording

Unlike analog soundcards which produce empty wave files (or noise) when no input signal is present, digital interfaces always need a valid input signal to start recording.

Taking this into account, RME added a comprehensive I/O signal status display to the HDSPe MADI, showing sample frequency, lock and sync status for every input.

The sample frequency shown in the fields Clock Mode and MADI Input Status is useful as a quick display of the current configuration of the unit and the connected external equipment. If no sample frequency is recognized, it will read 'No Lock'.

This way, configuring any suitable audio application for digital recording is simple. After selecting the correct input, HDSPe MADI displays the current sample frequency. This parameter can then be changed in the application's audio properties (or similar) dialog.

It often makes sense to monitor the input signal or send it directly to the output. This can be done at zero latency using **TotalMix** (see chapter 25).

An *automated* control of real-time monitoring can be achieved by Steinberg's ASIO protocol with RME's ASIO drivers and all ASIO 2 compatible programs. When 'ASIO Direct Monitoring' has been switched on, the input signal is routed in real-time to the output whenever a recording is started (punch-in).

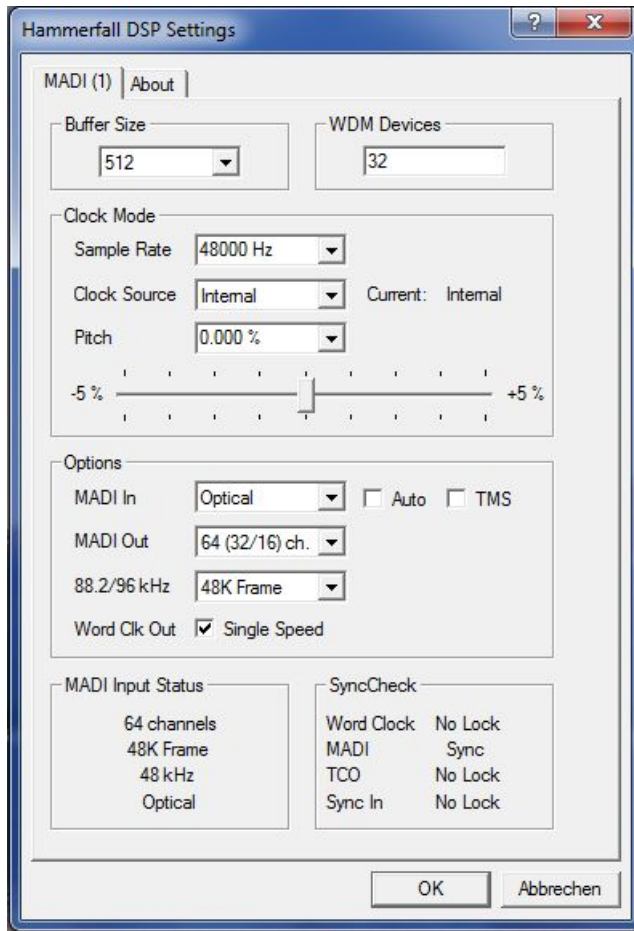

13. Operation under ASIO

13.1 General

Start the ASIO software and select **ASIO Hammerfall DSP** as the audio I/O device.

The HDSP system supports *ASIO Direct Monitoring* (ADM).

The HDSPe MADI's MIDI I/O can be used with both MME MIDI and DirectMusic MIDI.

At a sample rate of 88.2 or 96 kHz (Double Speed mode), the number of channels available at the MADI input and output is halved. At a sample rate of 176.4 or 192 kHz (Quad Speed mode), the number of channels is reduced to 16.

Note: When changing the sample rate range between Single, Double and Quad Speed the number of channels presented from the ASIO driver will change too. This may require a reset of the I/O list in the audio software.

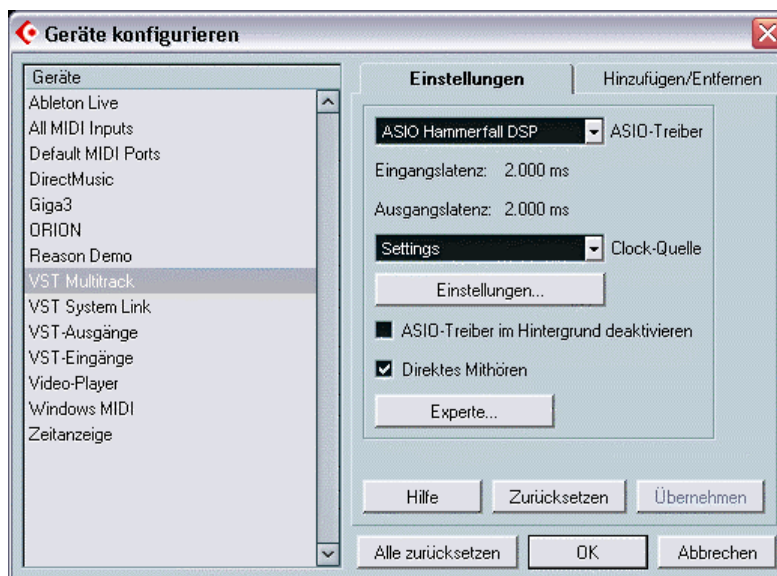

13.2 Known Problems

If a computer does not provide sufficient CPU-power and/or sufficient PCIe-bus transfer rates, then drop outs, crackling and noise will appear. Raising the buffer size in the Settings dialog of the HDSP system helps in most cases. We recommend to deactivate all PlugIns to verify that these are not the reason for such effects.

Another common source of trouble is incorrect synchronization. ASIO does not support asynchronous operation, which means that the input and output signals not only have to use the same sample frequency, but also have to be in sync. Devices connected to the HDSPe MADI must be properly configured for Full Duplex operation. As long as SyncCheck (in the Settings dialog) only displays *Lock* instead of *Sync*, the devices have not been set up properly!

The same applies when using more than one HDSP system - they all have to be in sync. Else a periodically repeated noise will be heard.

RME supports *ASIO Direct Monitoring* (ADM). Please note that not all programs support ADM completely or error-free. The most often reported problem is the wrong behaviour of panorama in a stereo channel.

In case of a drift between audio and MIDI, or in case of a fixed deviation (MIDI notes placed close before or behind the correct position), the settings in Cubase/Nuendo have to be changed. At the time of print the option 'Use System Timestamp' should be activated. The HDSP system supports both MME MIDI and DirectMusic MIDI. It depends on the used application which one will work better.

14. Using multiple HDSPe MADI

The current driver supports operation of up to three HDSPe MADI. All cards of the HDSP and HDSPe system use the same driver, therefore can be used at the same time. All units have to be in sync, i.e. have to receive valid sync information either via word clock or by using AutoSync and feeding synchronized signals.

- If one of the HDSP systems is set to clock mode Master, all others have to be set to clock mode Slave, and have to be synced from the master, for example by feeding word clock. The clock modes of all units have to be set up correctly in their Settings dialogs.
- If all units are fed with a synchronous clock, i.e. all units show *Sync* in their Settings dialog, all channels can be used at once. This is especially easy to handle under ASIO, as the ASIO driver presents all units as one.

Note: TotalMix is part of the hardware of each HDSP system. Up to three mixers are available, but these are separated and can't interchange data. Therefore a global mixer for all units is not possible.

15. DIGICheck

The DIGICheck software is a unique utility developed for testing, measuring and analysing digital audio streams. Although this software is fairly self-explanatory, it still includes a comprehensive online help. DIGICheck 5.34 operates as multi-client ASIO host, therefore can be used in parallel to any software with both inputs and outputs (!). The following is a short summary of the currently available functions:

- **Level Meter.** High precision 24-bit resolution, 2/8/64 channels. Application examples: Peak level measurement, RMS level measurement, over-detection, phase correlation measurement, dynamic range and signal-to-noise ratios, RMS to peak difference (loudness), long term peak measurement, input check. Oversampling mode for levels higher than 0 dBFS. Vertical and horizontal mode. Slow RMS and RLB weighting filter. Supports visualization according to the K-system.
- **Hardware Level Meter for Input, Playback and Output.** As above, received pre-calculated directly from the HDSP system hardware with near zero CPU load.
- **Spectral Analyser.** World wide unique 10-, 20- or 30-band display in analog bandpass-filter technology. 192 kHz-capable!
- **Vector Audio Scope.** World wide unique Goniometer showing the typical afterglow of an oscilloscope-tube. Includes Correlation meter and level meter.
- **Surround Audio Scope.** Professional Surround Level Meter with extended correlation analysis.
- **Totalyser.** Spectral Analyser, Level Meter and Vector Audio Scope in a single window.
- **Bit Statistics & Noise.** Shows the true resolution of audio signals as well as errors and DC offset. Includes Signal to Noise measurement in dB and dBA, plus DC measurement.
- **Channel Status Display.** Detailed analysis and display of SPDIF and AES/EBU Channel Status data.
- **Global Record.** Long-term recording of all channels at lowest system load.
- **Completely multi-client.** Open as many measurement windows as you like, on any channels and inputs or outputs!

To install DIGICheck, go to the **\DIGICheck** directory on the RME Driver CD and run *setup.exe*. Follow the instructions prompted on the screen.

DIGICheck is constantly updated. The latest version is always found on our website www.rme-audio.com, section **Downloads / DIGICheck**.

17. Hotline – Troubleshooting

The newest information can always be found on our website www.rme-audio.com, section FAQ, Latest Additions.

The dialog 'New hardware component found' does not appear:

- Check whether the PCI Express interface is correctly inserted in the PCI Express slot.

The card and drivers have been installed correctly, but playback does not work:

- Check whether the Hammerfall DSP appears in the Device Manager. If the ' Hammerfall DSP' device has a yellow exclamation mark, then there is an address or interrupt conflict.
- Even if there is no yellow exclamation mark, it is still worth checking the 'Resources' tab.

The input signal cannot be monitored in real-time

- ASIO Direct Monitoring has not been enabled, and/or monitoring has been disabled globally (for example in TotalMix).

Playback works, but record doesn't

- Check that there is a valid signal at the input. If so, the current sample frequency is displayed in the Settings dialog.
- Check whether the HDSP system has been selected as recording device in the audio application.
- Check whether the sample frequency set in the audio application ('Recording properties' or similar) matches the input signal.

Crackle during record or playback

- Increase the number and size of buffers in the 'Settings' dialog or in the application.
- Try different cables (coaxial or optical) to rule out any defects here.
- Check that cables/devices have not been connected in a closed loop. If so, set the system's clock mode to 'Master'.

User's Guide



HDSPe MADI

- ▶ **Driver Installation and Operation – Mac OS X**

17. Driver and Flash Update

17.1 Driver Installation

First fit the card (see 5. Hardware Installation), then switch on the computer and install the drivers from the RME Driver CD. The driver file is located in the folder **HDSPe Series**. Installation works automatically by a double-click on the file **HDSPe.pkg**.

RME recommends to download the latest driver version from the RME website! If done, the procedure is as follows:

Double-click onto **hdspe_x86_xx.zip** to expand the archive file to the folder **hdspe_xxx** which includes the driver file **hdspe.pkg**. Installation works automatically by a double-click on this file.

During driver installation the programs **HDSPe Settings** and **HDSPe Mixer** (TotalMix) are copied to the Applications folder. It is recommended to link these two programs to the Dock so that they are always available.

Reboot the computer when installation is done.

17.2 Driver Update

In case of a driver update it's not necessary to remove the old driver first, it will be overwritten during the installation. In case of problems the driver files can be deleted manually by dragging them to the trash bin:

```
/Applications/Hammerfall DSP Mixer  
/Applications/Hammerfall DSP Settings  
/Library/Audio/MIDI Drivers/HDSP MADI MIDI.plugin  
/System/Library/Extensions/HDSPMADI.kext  
/Users/username/Library/Preferences/Hammerfall DSP folder  
/Users/username/Library/Preferences/com.rme.HDSPeMixer.plist  
/Users/username/Library/Preferences/com.rme.HDSPeSettings.plist  
/Library/LaunchAgents/de.rme-audio.hdspAgent.plist
```

17.3 Firmware Update

The Flash Update Tool updates the HDSPe MADI card to the latest firmware version. It requires an already installed driver.

Start the program **HDSPe Flash Update**. The Flash Update Tool displays the current revision of the HDSP interface, and whether it needs an update or not. If so, then simply press the 'Update' button. A progress bar will indicate when the flash process is finished. The bar moves slowly first (program), then faster (verify).

If more than one interface card is installed, all cards can be flashed by changing to the next tab and repeating the process.

After the update the PCI Express card needs to be reset. This is done by powering down and shutting off the computer. A warm boot is not enough!

When the update fails (status: failure), the card's second BIOS will be used from the next cold boot on (Secure BIOS Technology). Therefore the card stays fully functional. The flash process should then be tried again on a different computer.

18. Configuring the HDSPe MADI

18.1 Settings Dialog

Configuring the HDSPe MADI is done via its own settings dialog. The panel 'Settings' can be opened by clicking on the hammer icon in the dock. The mixer of the HDSPe MADI, TotalMix, can be opened by clicking on the mixer icon in the dock.

The Hammerfall DSP's hardware offers a number of helpful, well thought-of practical functions and options which affect how the card operates - it can be configured to suit many different requirements. The following is available in the 'Settings' dialog:

- Input selection
- Configuration of digital I/Os
- Synchronization behaviour
- State of input and output
- Current sample rate

Any changes performed in the Settings dialog are applied immediately - confirmation (e.g. by exiting the dialog) is not required.

However, settings should not be changed during playback or record if it can be avoided, as this can cause unwanted noises.

The About tab shows the current firmware and driver version.

Use the drop down menu **Properties For** to select the card to be configured.



Sample Rate

Used to set the current sample rate. This is the same setting as in the Audio MIDI Setup, just added here for your convenience.

MADI Out

Defines the format of the MADI output signal. MADI can be a 56 or 64 channel signal.

96 kHz

Sample rates higher than 48 kHz can be transmitted using the normal 48K Frame, or using a native 96K Frame at the card's output.

MADI In

Defines the input for the MADI signal. 'Optical' relates to the optical input, 'Coaxial' to the BNC socket. 'Auto Select' works as automatic input selection, in case only optical or coaxial is present as input signal. AutoSelect also enables redundancy operation. If the current input signal fails, the other input will be used immediately, provided a valid signal is found there.

Word Clock Out

The word clock output signal usually equals the current sample rate. Selecting *Single Speed* causes the output signal to always stay within the range of 32 kHz to 48 kHz. So at 96 kHz and 192 kHz sample rate, the output word clock is 48 kHz.

Clock Mode

The unit can be configured to use its internal clock source (Master), or the clock source pre-defined via *Pref. Sync Ref* (AutoSync).

Pref. Sync Ref.

Used to pre-select the desired clock source. If the selected source isn't available, the unit will change to the next available one. The current clock source and sample rate is displayed in the *AutoSync Reference* display.

The automatic clock selection checks and changes between the clock sources Word Clock, MADI, TCO and Sync In.

Input Status

Displays the state of the current input signal:

- Channel format (64 or 56 channels)
- Frame format (48K or 96K)
- Sample rate (measured)
- Active input (optical or coaxial)



System Clock

Shows the current clock state and sample rate of the HDSP system. The system is either Master (using its own clock) or Slave (see AutoSync Ref).

SyncCheck

SyncCheck indicates whether there is a valid signal (Lock) for the inputs Word Clock, MADI, TCO and Sync In, or if there is a valid *and* synchronous signal (Sync). The *AutoSync Reference* display shows the input and frequency of the current sync source.

18.2 Clock Modes - Synchronisation

AutoSync

The HDSPe MADI has been equipped with *AutoSync*, an automatic clock source selection, which adopts the first available input with a valid digital signal as the clock reference input. The input currently used as sync reference is shown in the *AutoSync Ref* status field, together with its current sample frequency.

AutoSync guarantees that normal record and record-while-play will always work correctly. In certain cases however, AutoSync may cause feedback in the digital carrier, so synchronization breaks down. To remedy this, switch the HDSP's clock mode over to 'Master'.

Via *Pref. Sync Ref* (preferred synchronization reference) a preferred input can be defined. As long as the card sees a valid signal there, this input will be designated as the sync source, otherwise the other inputs will be scanned in turn. If none of the inputs are receiving a valid signal, the card automatically switches clock mode to 'Master'.

Thanks to its AutoSync technique and lightning fast PLL, the HDSP is not only capable of handling standard frequencies, but also any sample rate between 28 and 200 kHz. Even the word clock input, which most users will use in varispeed operation, allows any frequency between 28 kHz and 200 kHz.

The HDSPe MADI's outstanding clock control allows for a synchronization of the output signal to the word clock's input signal not only at identical sample rates, but also at half, quarter, double and quad sample rates. A playback of 96 kHz can easily be synchronized via a 48 kHz word clock signal.

SyncCheck

If several digital devices are to be used simultaneously in a system, they not only have to operate with the same sample frequency but also be synchronous with each other. This is why digital systems always need a single device defined as 'master', which sends the same clock signal to all the other ('slave') devices.



Remember that a digital system can only have one master! If the HDSPe MADI's clock mode is set to Master, all other devices must be set to Slave.

RME's exclusive **SyncCheck** technology enables an easy to use check and display of the current clock status. The SyncCheck field indicates whether no signal (No Lock), a valid signal (Lock) or a valid *and* synchronous signal (Sync) is present at each of the digital clock source inputs. The 'AutoSync Ref' display shows the current sync source and the measured frequency.

In practice, SyncCheck provides the user with an easy way of checking whether all digital devices connected to the system are properly configured. With SyncCheck, finally anyone can master this common source of error, previously one of the most complex issues in the digital studio world.

19. Mac OS X FAQ

19.1 Round about Driver Installation

The driver with the file suffix **zip** provided by RME is a compressed archive. Zip is directly supported by OS X, a double click on the file is all one needs to do.

The driver consists of a package file (pkg). A double click will start the OS X installer.

The actual audio driver appears as a kernel extension file. The installer copies it to **>System/Library/Extensions<**. Its name is **HDSPMADI.kext**. It is visible in the Finder, allowing you to verify date and driver version. Yet, in fact this again is a folder containing subdirectories and files.

Nonetheless, this 'driver file' can be removed by simply dragging it to the trash bin. This can be helpful in case a driver installation fails.

19.2 MIDI doesn't work

In some cases the applications do not show the MIDI port. The reason for this is usually visible within the **Audio MIDI Setup**. It displays no RME MIDI device, or the device is greyed out and therefore inactive. Mostly, removing the greyed out device and searching for MIDI devices again will solve the problem.

The HDSP MIDI driver is a plugin. During installation it will be copied to **>Library/Audio/MIDI Drivers<**. Its name is **HDSP MADI MIDI.plugin**. The file can be displayed in the Finder and also be removed by simply dragging it to the trash bin.

19.3 Supported Sample Rates

RME's Mac OS X driver supports all sampling frequencies provided by the hardware. This includes **32 kHz** and **64 kHz**, and even **128 kHz**, **176.4 kHz** and **192 kHz**.

But not any software will support all the hardware's sample rates. The hardware's capabilities can easily be verified in the **Audio MIDI Setup**. Select **Audio devices** under **Properties of:** and choose the Hammerfall. A click on **Format** will list the supported sample frequencies.

19.4 Repairing Disk Permissions

Repairing permission can solve problems with the installation process - plus many others. To do this, launch **Disk Utility** located in **Utilities**. Select your system drive in the drive/volume list to the left. The **First Aid** tab to the right now allows you to check and repair disk permissions.

19.5 Various Information

The driver requires 10.5.8 or higher.

Via **>System Preferences/ Audio-MIDI Setup<** the hardware can be configured for the system wide usage. Programs that don't support card or channel selection will use the device selected as **Standard-Input** and **Standard-Output**. (Soundstudio, Mplayer, Amplitude etc.).

In the lower part of the window, the audio hardware's capabilities are shown and can be changed in some cases. On the record side no changes are possible. Programs that don't support channel selection will always use channels 1/2, the first stereo pair. To access other inputs use the following workaround with TotalMix: route the desired input signal to output channels 1/2. Hold the Ctrl key down and click on the labels AN1 and AN2 in the third row. Their labels turn red, the internal loop mode is active. Result: the desired input signal is now available at input channel 1/2, without further delay/latency.

Use **Speaker Setup** to freely configure the playback to all available channels. Even multichannel playback (Surround, DVD Player) can be set up this way.

20. Using more than one HDSPe System

OS X supports the usage of more than one audio device within an audio software. This is done via the Core Audio function **Aggregate Devices**, which allows to combine several devices into one.

The current driver supports up to three HDSPe in any combination. All units have to be in sync, i.e. have to receive valid sync information either via word clock or by feeding synchronized signals.

- If one of the units is set to clock mode Master, all others have to be set to clock mode Slave, and have to be synced from the master, for example by feeding word clock. The clock modes of all units have to be set up correctly in the Settings dialog.
- If all units are fed with a synchronous clock, i.e. all units show *Sync* in their Settings dialog, all channels can be used at once.

Note: TotalMix is part of the hardware of each HDSPe system. Up to three mixers are available, but these are separated and can't interchange data. Therefore a global mixer for all units is not possible.

21. DIGICheck Mac

The DIGICheck software is a unique utility developed for testing, measuring and analysing digital audio streams. Although this Windows software is fairly self-explanatory, it still includes a comprehensive online help. DIGICheck 0.64 operates in parallel to any software, showing all input data. The following is a short summary of the currently available functions:

- **Level Meter.** High precision 24-bit resolution, 2/8/18 channels. Application examples: Peak level measurement, RMS level measurement, over-detection, phase correlation measurement, dynamic range and signal-to-noise ratios, RMS to peak difference (loudness), long term peak measurement, input check. Oversampling mode for levels higher than 0 dBFS. Supports visualization according to the K-System.
- **Hardware Level Meter for Input, Playback and Output.** Reference Level Meter freely configurable, causing near zero CPU load, because calculated from the Fireface hardware.
- **Vector Audio Scope.** World wide unique Goniometer showing the typical afterglow of a oscilloscope-tube. Includes Correlation meter and level meter.
- **Surround Audio Scope.** Professional Surround Level Meter with extended correlation analysis, ITU weighting and ITU summing meter.
- **Spectral Analyser.** World wide unique 10-, 20- or 30-band display in analog bandpass filter technology. 192 kHz-capable!
- **Totalyser.** Spectral Analyser, Level Meter and Vector Audio Scope in a single window.
- **Completely multi-client.** Open as many measurement windows as you like, on any channels and inputs or outputs!

To install DIGICheck, go to the **\DIGICheck** directory on the RME Driver CD and run *setup.exe*. Follow the instructions prompted on the screen.

DIGICheck is constantly updated. The latest version is always available on our website www.rme-audio.com, section **Downloads / DIGICheck**.

22. Hotline – Troubleshooting

The newest information can always be found on our website www.rme-audio.com, section Support, Macintosh OS.

Playback works, but record doesn't:

- Check that there is a valid signal at the input.
- Check whether the Hammerfall DSP has been selected as recording device in the audio application.
- Check whether the sample frequency set in the audio application ('Recording properties' or similar) matches the input signal.
- Check that cables/devices have not been connected in a closed loop. If so, set the system's clock mode to Master.

Crackle during record or playback:

- Increase the number and size of buffers in the application.
- Try different cables to rule out any defects here.

The card and drivers have been installed correctly, but playback does not work:

- Is Hammerfall DSP listed in the System Profiler/PCI? (Vendor 10EE, Device ID 3FC6).
- Has Hammerfall DSP been selected as current playback device in the audio application?

User's Guide



HDSPe MADI

▶ Connections and TotalMix

23. Connections

23.1 Headphones

HDSPe MADI offers a hi-quality analog monitor output. The short circuit protected stereo line output provides high output level, low impedance, and is available via a 6.3 mm (1/4") TRS jack. Therefore it is also suitable for a direct use with headphones.

The analog output is directly driven from the channels 63/64, in Double Speed mode with channels 31/32, in Quad Speed mode with channels 15/16. Its output volume is controlled by the hardware output faders of channel 63/64 in TotalMix. Additionally the analog output can play back any input or playback signal (submix, for example factory preset 5, 6 and 7).

The analog output does not include speaker protection. When switching the computer on and off, noise may occur at the analog outputs.

In case the output should operate as line out, an adapter TRS plug to RCA phono plugs, or TRS plug to TS plugs is required.

The pin assignment follows international standards. The left channel is connected to the tip, the right channel to the ring of the TRS jack/plug.

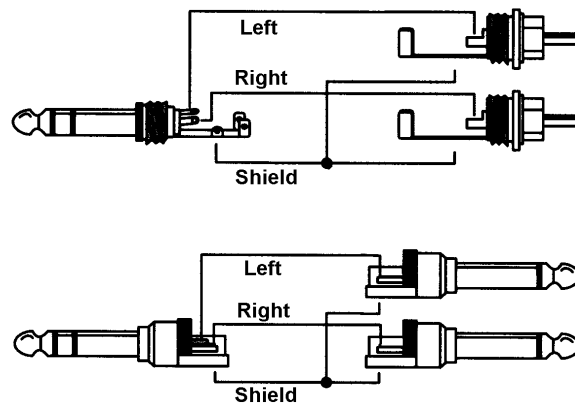

23.2 MADI I/Os

The BNC input's ground-free design is built according to AES10-1991. The input impedance is 75 Ohm. It will operate error-free from about 180 mVpp on.

The optical input and output uses a FDDI (ISO/IEC 9413-3) compatible optical module, according to AES10-1991. More information can be found in chapter 30.1, MADI Basics.

HDSPe MADI includes automatic input selection (Safe Mode Input). In case the current input signal fails, the unit switches to the other input immediately. This mode, called redundancy mode, offers improved safety against errors on the transmission line. Switching the inputs is done in about one second. Redundancy operation is displayed in the Settings dialog.

The BNC output is built according to AES10-1991. The output's impedance is 75 Ohm. The output voltage will be 600 mVpp when terminated with 75 Ohm.

23.3 MIDI

The HDSPe MADI offers two MIDI I/O via 5-pin DIN connectors. The MIDI ports are added to the system by the driver. Using MIDI capable software, these ports can be accessed under the name *MADI MIDI*. Using more than one HDSPe MADI, a consecutive number is added to the port name, like *MADI MIDI In 1 (2)* etc.

The third software-only MIDI port, MADI MIDI In 3 (1) and MADI MIDI Out 3 (1), receives and transmits MIDI data via MADI. This allows for a direct communication between systems with HDSPe MADI cards. Additionally MIDI data can be transmitted from/to other RME devices with MADI ports, and both can be MIDI remote controlled without any additional line or cabling between computer (MADI card) and unit.

24. Word Clock

24.1 Word Clock Input and Output

SteadyClock guarantees an excellent performance in all clock modes. Based on the highly efficient jitter suppression, the HDSPe MADI refreshes and cleans up any clock signal, and provides it as reference clock at the BNC output (see chapter 30.6).

Input

The HDSPe MADI's word clock input is active when *Pref. Sync Ref* in the Settings dialog has been switched to *Word Clock*, the clock mode *AutoSync* has been activated, and a valid word clock signal is present. The signal at the BNC input can be Single, Double or Quad Speed, the HDSPe MADI automatically adapts to it. As soon as a valid signal is detected, the green LED is lit, and the Settings dialog shows either Lock or Sync (see chapter 30.2).

Thanks to RME's *Signal Adaptation Circuit*, the word clock input still works correctly even with heavily mis-shaped, dc-prone, too small or overshoot-prone signals. Thanks to automatic signal centering, 300 mV (0.3V) input level is sufficient in principle. An additional hysteresis reduces sensitivity to 1.0 V, so that over- and undershoots and high frequency disturbances don't cause a wrong trigger.

The word clock input is shipped as high impedance type (not terminated). A push switch allows to activate internal termination (75 Ohms). The switch is found beside the word clock input socket. Use a small pencil or similar and carefully push the blue switch so that it snaps into its lock position. The yellow LED will be lit when termination is active. Another push will release it again and de-activate the termination.

Output

The word clock output of the HDSPe MADI is constantly active, providing the current sample frequency as word clock signal. As a result, in Master mode the provided word clock is defined by the currently used software or the DDS dialog. In Slave mode the provided frequency is identical to the one present at the currently chosen clock input. When the current clock signal fails, the HDSPe MADI switches to Master mode and adjusts itself to the next, best matching frequency (44.1 kHz, 48 kHz etc.).

Selecting *96 kHz – 48K Frame* in the Settings dialog causes the output signal to always stay within the range of 32 kHz to 48 kHz. So at 96 kHz sample rate, the output word clock is 48 kHz.

The received word clock signal can be distributed to other devices by using the word clock output. With this the usual T-adaptor can be avoided, and the HDSPe MADI operates as *Signal Refresher*. This kind of operation is highly recommended, because

- input and output are phase-locked and in phase (0°) to each other
- SteadyClock removes nearly all jitter from the input signal
- the exceptional input (1 Vpp sensitivity instead of the usual 2.5 Vpp, dc cut, Signal Adaptation Circuit) plus SteadyClock guarantee a secure function even with highly critical word clock signals
- the Expansion Board provides two word clock outputs with separated driver stages

Thanks to a low impedance, but short circuit proof output, the HDSPe MADI delivers 4 Vpp to 75 Ohms. For wrong termination with 2 x 75 Ohms (37.5 Ohms), there are still 3.3 Vpp fed into the network – per output!

24.2 Technical Description and Usage

In the analog domain one can connect any device to another device, a synchronisation is not necessary. Digital audio is different. It uses a clock, the sample frequency. The signal can only be processed and transmitted when all participating devices share the same clock. If not, the signal will suffer from wrong samples, distortion, crackle sounds and drop outs.

AES/EBU, SPDIF, ADAT and MADI are self-clocking, an additional word clock connection in principle isn't necessary. But when using more than one device simultaneously problems are likely to happen. For example any self-clocking will not work in a loop cabling, when there is no 'master' (main clock) inside the loop. Additionally the clock of all participating devices has to be synchronous. This is often impossible with devices limited to playback, for example CD players, as these have no SPDIF input, thus can't use the self clocking technique as clock reference.

In a digital studio synchronisation is maintained by connecting all devices to a central sync source. For example the mixing desk works as master and sends a reference signal, the word clock, to all other devices. Of course this will only work as long as all other devices are equipped with a word clock or sync input, thus being able to work as slave (some professional CD players indeed have a word clock input). Then all devices get the same clock and will work in every possible combination with each other.



Remember that a digital system can only have one master!

But word clock is not only the 'great problem solver', it also has some disadvantages. The word clock is based on a fraction of the really needed clock. For example SPDIF: 44.1 kHz word clock (a simple square wave signal) has to be multiplied by 256 inside the device using a special PLL (to about 11.2 MHz). This signal then replaces the one from the quartz crystal. Big disadvantage: because of the high multiplication factor the reconstructed clock will have great deviations called jitter. The jitter of a word clock is multiple times higher than the one of a quartz based clock.

The end of these problems should have been the so called Superclock, which uses 256 times the word clock frequency. This equals the internal quartz frequency, so no PLL for multiplying is needed and the clock can be used directly. But reality was different, the Superclock proved to be much more critical than word clock. A square wave signal of 11 MHz distributed to several devices - this simply means to fight with high frequency technology. Reflections, cable quality, capacitive loads - at 44.1 kHz these factors may be ignored, at 11 MHz they are the end of the clock network. Additionally it was found that a PLL not only generates jitter, but also rejects disturbances. The slow PLL works like a filter for induced and modulated frequencies above several kHz. As the Superclock is used without any filtering such a kind of jitter and noise suppression is missing.

The actual end of these problems is offered by the **SteadyClock** technology of the HDSPe MADI. Combining the advantages of modern and fastest digital technology with analog filter techniques, re-gaining a low jitter clock signal of 22 MHz from a slow word clock of 44.1 kHz is no problem anymore. Additionally, jitter on the input signal is highly rejected, so that even in real world usage the re-gained clock signal is of highest quality.

This is especially true when extracting the word clock out of a MADI signal. Caused by the MADI format itself, such a signal will have around 80 ns of jitter, which is reduced to about 1 ns by SteadyClock.

24.3 Cabling and Termination

Word clock signals are usually distributed in the form of a network, split with BNC T-adapters and terminated with resistors. We recommend using off-the-shelf BNC cables to connect all devices, as this type of cable is used for most computer networks. You will find all the necessary components (T-adapters, terminators, cables) in most electronics and/or computer stores. The latter usually carries 50 Ohms components. The 75 Ohms components used for word clock are part of video technology (RG59).

Ideally, the word clock signal is a 5 Volt square wave with the frequency of the sample rate, of which the harmonics go up to far above 500 kHz. To avoid voltage loss and reflections, both the cable itself and the terminating resistor at the end of the chain should have an impedance of 75 Ohm. If the voltage is too low, synchronization will fail. High frequency reflection effects can cause both jitter and sync failure.

Unfortunately there are still many devices on the market, even newer digital mixing consoles, which are supplied with a word clock output that can only be called unsatisfactory. If the output breaks down to 3 Volts when terminating with 75 Ohms, you have to take into account that a device, of which the input only works from 2.8 Volts and above, does not function correctly already after 3 meter cable length. So it is not astonishing that because of the higher voltage, word clock networks are in some cases more stable and reliable if cables are not terminated at all.

Ideally all outputs of word clock delivering devices are designed with very low impedance, but all word clock inputs as high impedance types, in order to not weaken the signal on the chain. But there are also negative examples, when the 75 Ohms are built into the device and cannot be switched off. In this case the network load is often 2 x 75 Ohms, and the user is forced to buy a special word clock distributor. Note that such a device is generally recommended for bigger studios.

The HDSPe MADI's word clock input can be high-impedance or terminated internally, ensuring maximum flexibility. If termination is necessary (e.g. because the card is the last device in the chain), activate the switch TERM between the BNC jacks on the Expansion Board so that the yellow TERM LED lights up (see chapter 24.1).

In case the HDSPe MADI resides within a chain of devices receiving word clock, plug a T-adaptor into its BNC input jack, and the cable supplying the word clock signal to one end of the adapter. Connect the free end to the next device in the chain via a further BNC cable. The last device in the chain should be terminated using another T-adaptor and a 75 Ohm resistor (available as short BNC plug). Of course devices with internal termination do not need T-adaptor and terminator plug.



Due to the outstanding SteadyClock technology of the HDSPe MADI, we recommend not to pass the input signal via T-adaptor, but to use the card's word clock output instead. Thanks to SteadyClock, the input signal will both be freed from jitter and - in case of loss or drop out - be reset to a valid frequency.

24.4 Operation

The HDSPe MADI's word clock input is active when *Pref. Sync Ref* in the Settings dialog has been set to *Word Clock*, the clock mode *AutoSync* has been activated, and a valid word clock signal is present. The signal at the BNC input can be Single, Double or Quad Speed, the HDSP automatically adapts to it. As soon as a valid signal is detected, the green LED at the bracket is lit, and the Settings dialog shows either Lock or Sync (see chapter 30.2). In the status display *AutoSync Ref* the display changes to *Word*. This message has the same function as the green Lock LED, but appears on the monitor, i.e. the user can check immediately whether a valid word clock signal is present and is currently being used.

In the line *Freq.*, the *AutoSync Ref* shows the frequency of the reference signal, measured by the hardware. In this case the frequency of the current word clock signal is measured and displayed.

25. TotalMix: Routing and Monitoring

25.1 Overview

The HDSPe MADI includes a powerful digital real-time mixer, the *Hammerfall DSP mixer*, based on RME's unique, sample-rate independent **TotalMix** technology. It allows for practically unlimited mixing and routing operations, with all inputs and playback channels simultaneously, to any hardware outputs.

Here are some typical applications for TotalMix:

- Setting up delay-free submixes (headphone mixes). The HDSPe MADI allows for up to 32 (!) fully independent stereo submixes. On an analog mixing desk, this would equal 64 (!) Aux sends.
- Unlimited routing of inputs and outputs (free utilisation, patchbay functionality).
- Distributing signals to several outputs at a time. TotalMix offers state-of-the-art splitter and distributor functions.
- Simultaneous playback of different programs using only one stereo output. The ASIO multi-client driver allows to use several programs at the same time, but only on different playback channels. TotalMix provides the means to mix and monitor these on a single stereo output.
- Mixing of the input signal to the playback signal (complete ASIO Direct Monitoring). RME not only is *the* pioneer of ADM, but also offers the most complete implementation of the ADM functions.
- Integration of external devices. Use TotalMix to insert external effects devices, be it in the playback or in the record path. Depending on the current application, the functionality equals insert or effects send and effects return, for example as used during real-time monitoring when adding some reverb to the vocals.

Every single input channel, playback channel and hardware output features a Peak and RMS level meter, calculated in hardware (hardware output is Peak only). These level displays are very useful to determine the presence and routing destinations of the audio signals.

For a better understanding of the TotalMix mixer you should know the following:

- As shown in the block diagram (next page), the record signal usually stays un-altered. TotalMix does not reside within the record path, and does not change the record level or the audio data to be recorded (exception: loopback mode).
- The hardware input signal can be passed on as often as desired, even with different levels. This is a big difference to conventional mixing desks, where the channel fader always controls the level for all routing destinations simultaneously.
- The level meter of inputs and playback channels are connected pre-fader, to be able to visually monitor where a signal is currently present. The level meters of the hardware's outputs are connected post-fader, thus displaying the actual output level.

RME TotalMix
 Hammerfall DSP Mixer
 HDSP MADI
 Block Diagram, 08/2005

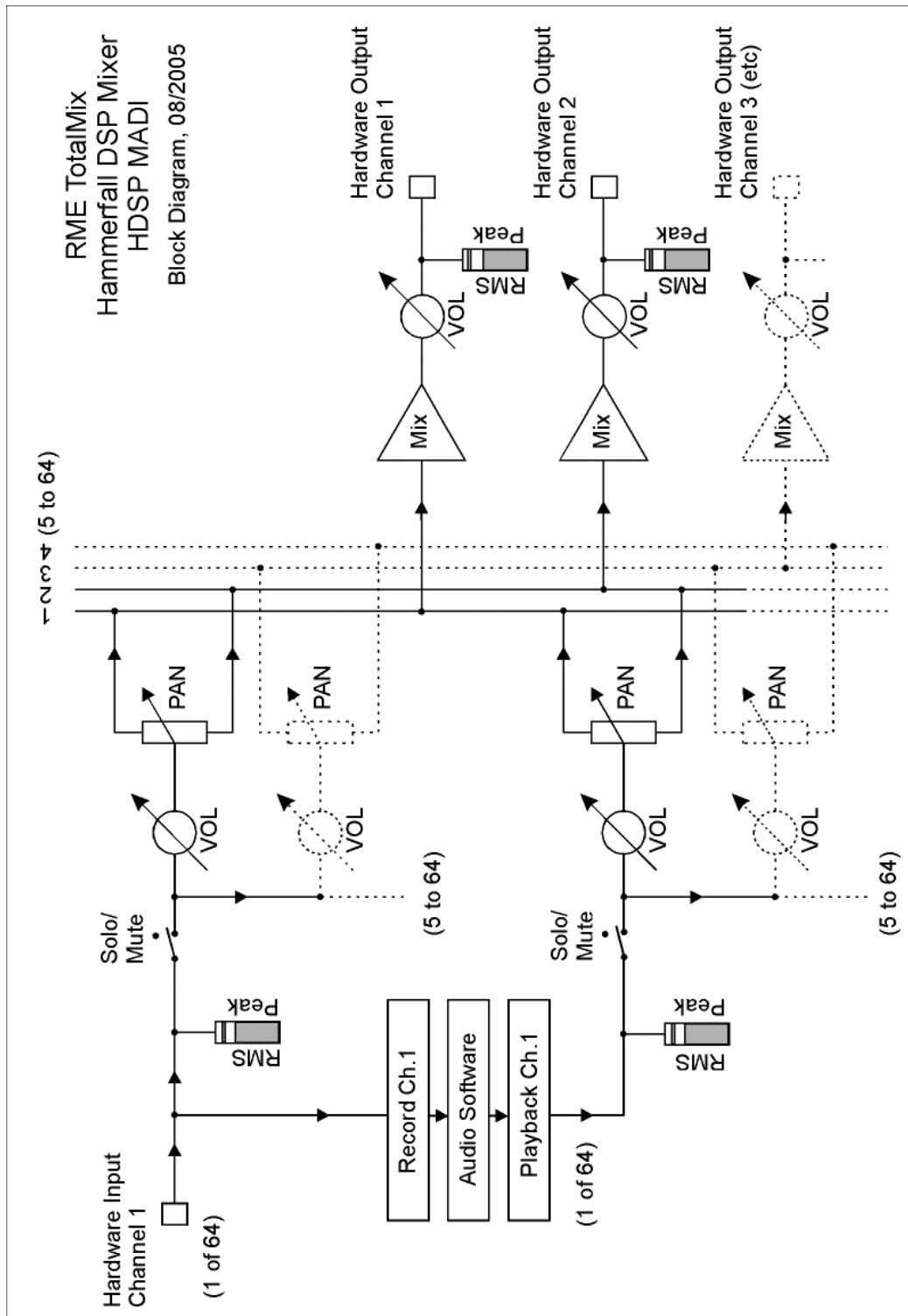

25.2 The User Interface

The visual design of the TotalMix mixer is a result of its capability to route hardware inputs and software playback channels to any hardware output. The HDSPe MADI provides 64 input channels, 64 software playback channels, and 64 hardware output channels:

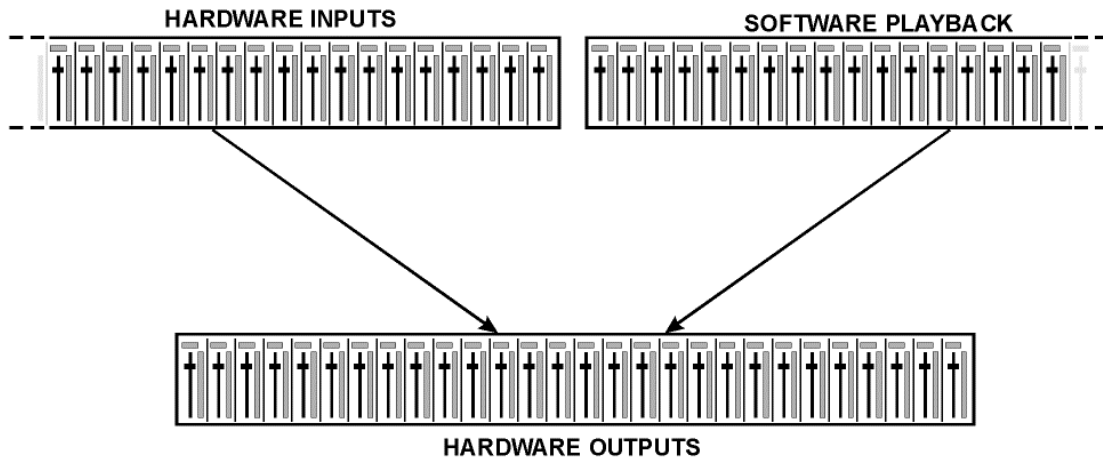

128 channels don't fit on the screen side by side, neither does such an arrangement provide a useful overview. Therefore the channels have been arranged as known from an *Inline* desk, so that the row *Software Playback* equals the *Tape Return* of a real mixing desk:

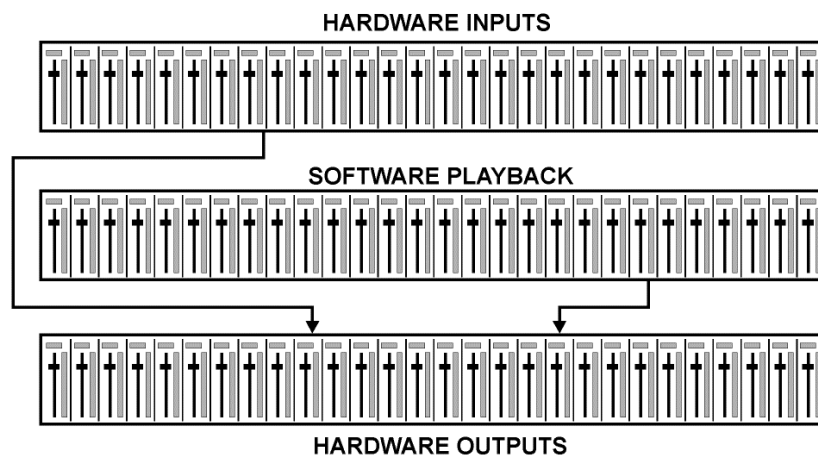

- Top row: Hardware inputs. The level shown is that of the input signal, i. e. fader independent. Via fader and routing field, any input channel can be routed and mixed to any hardware output (bottom row).
- Middle row: Playback channels (playback tracks of the audio software). Via fader and routing field, any playback channel can be routed and mixed to any hardware output (third row).
- Bottom row (third row): Hardware outputs. Here, the total level of the output can be adjusted. This may be the level of connected loudspeakers, or the necessity to reduce the level of an overloaded submix.

Usage: simply click on the hardware output channel where you want to have an audio signal. This channel turns brighter, means it is selected as current submix. Now move the faders up from all sources - input and playback channels - that you want to hear at the submix output.

The following chapters explain step by step all functions of the user interface.

25.3 Elements of a Channel

A single channel consists of various elements:

Input channels and playback channels each have a mute and solo button.

Below there is the panpot, realized as indicator bar (L/R) in order to save space.

In the field below, the present level is displayed in RMS or Peak, being updated about every half a second. Overs (overload) are indicated here by an additional red dot.

Next is the fader with a level meter. The meter shows both peak values (zero attack, 1 sample is enough for a full scale display) by means of a yellow line, and mathematically correct RMS values by means of a green bar. The RMS display has a relatively slow time constant, so that it shows the average loudness quite well.

Below the fader, the current gain and panorama values are shown.

The grey area shows the channel name. Selecting one or more channels is done by clicking on the grey label which turns orange then. A click in the third row with pressed Ctrl-key activates internal loopback mode, the label turns red. A right mouse click opens a dialog to type in a new name.



The black area (routing field) shows the current routing target. A mouse click opens the routing window to select a routing target. The list shows all currently activated routings by checkmarks in front of the routing targets.

25.4 Tour de TotalMix

This chapter is a practical guide and introduction on how to use TotalMix, and on how TotalMix works.

Starting up TotalMix the last settings are recalled automatically. When executing the application for the first time, a default file is loaded, sending all playback tracks 1:1 to the corresponding hardware outputs with 0 dB gain, and activating phones monitoring.

Hold down Ctrl and click on preset button 5 to make sure that factory preset 5 is loaded. The faders in the top row are set to maximum attenuation (called m.a. in the following), so there is no monitoring of the input channels. The **Submix View** is active, therefore for improved overview all outputs except 63/64 are greyed out. Additionally all faders are set to the current routing target 63/64. All faders of the middle row are set to 0 dB, so no matter on which channels a playback happens, the audio will be audible via the Phones output. Just try it!

We will now create a submix on outputs 1+2. Please start a multitrack playback. In the third row, click on the channels of hardware output 1 or 2. The Submix View changes to 1/2. Both the fader settings and the output levels of all other channels are still visible, but greyed out for improved orientation.

As soon as 1/2 became active, all faders of the second row jumped to their bottom position – except those of playback channels 1/2. This is correct, because as mentioned above the factory preset includes a 1:1 routing. Click on 3/4 and the faders above are the only active ones, same for 5/6 and so on.

Back to 1/2. Now you can change all the faders of all inputs and playback channels just as you like, thus making any input and playback signals audible via the outputs 1/2. The panorama can be changed too. Click into the area above the fader and drag the green bar in order to set the panorama between left and right. The level meters of the third row display the level changes in real-time.

As shown it is very easy to set up a specific submix for whatever output: select output channel, set up fader and pans of inputs and playbacks – ready!

For advanced users sometimes it makes sense to work without Submix View. Example: you want to see and set up some channels of different submixes simultaneously, without the need to change between them all the time. Switch off the Submix View by a click on the green button. Now the black routing fields below the faders no longer show the same entry ('1+2'), but completely different ones. The fader and pan position is the one of the individually shown routing destination.

In playback channel 1 (middle row), labelled Out 1, click onto the routing field below the label. A list pops up, showing a checkmark in front of '1+2' and '63+64'. So currently playback channel 1 is sent to these two routing destinations. Click onto '7+8'. The list disappears, the routing field no longer shows '1+2', but '7+8'. Now move the fader with the mouse. As soon as the fader value is unequal m.a., the present state is being stored and routing is activated. Move the fader button to around 0 dB. The present gain value is displayed below the fader in green letters.

In the lower row, on channel 7, you can see the level of what you are hearing from output 7. The level meter of the hardware output shows the outgoing level. Click into the area above the fader and drag the mouse in order to set the panorama, in this case the routing between channels 7 and 8. The present pan value is also being displayed below the fader.

Please carry out the same steps for Out 2 now, in order to route it to output 8 as well.

In short: While editing the Submix 7+8 you have direct access to other submixes on other channels, because their routing fields are set to different destinations. And you get a direct view of how their faders and panoramas are set up.

 *This kind of visual presentation is very powerful, but for many users hard to understand, and requires a deep understanding of complex routing visualizations. Therefore we usually recommend to work in **Submix View**.*

Often signals are stereo, i. e. a pair of two channels. It is therefore helpful to be able to make the routing settings for two channels at once. Hold down the Ctrl-key and click into the routing field of Out 3. The routing list pops up with a checkmark at '3+4'. Select '7+8'. Now, Out 4 has already been set to '7+8' as well.

When you want to set the fader to exactly 0 dB, this can be difficult, depending on the mouse configuration. Move the fader close to the 0 position and now press the Shift-key. This activates the fine mode, which stretches the mouse movements by a factor of 8. In this mode, a gain setting accurate to 0.1 dB is no problem at all.

Please set Out 4 to a gain of around -20 dB and the pan close to center. Now click onto the routing field. You'll now see three checkmarks, at '3+4', '7+8' and '63+64'. Click onto '61+62'. The window disappears, fader and pan jump to their initial values, the signal can now be routed to the outputs 61 and 62. You can continue like this until all entries have got a checkmark, i. e. you can send the signal to all outputs simultaneously.

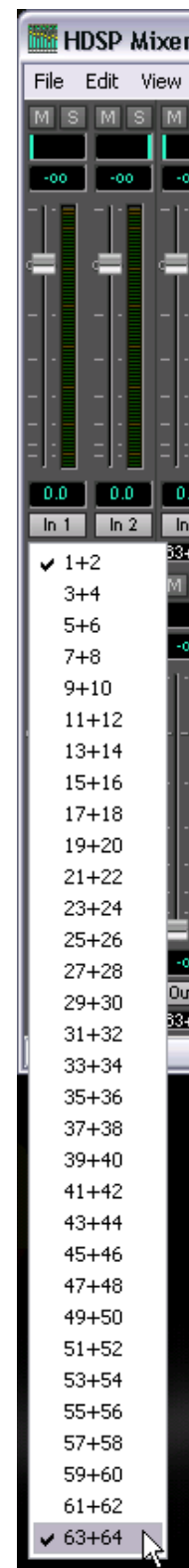

You will certainly have noticed that the signal at the outputs 7/8 did not change while you were routing channel 4 to other outputs and setting different gain values for those. With all analog and most digital mixing desks, the fader setting would affect the level for every routed bus - not so for TotalMix. TotalMix allows for setting all fader values individually. Therefore the faders and the panpots jump to the appropriate setting as soon as another routing is chosen.

Sometimes you will want the routings not to be independent. Let's say you have sent a signal to several submixes, and now want to change the signal's volume a bit on *all* these submixes. Dragging the faders by use of the right mouse button activates **Post Send** mode and causes all routings of the current input or playback channel to be changed in a relative way. Please note that the fader settings of all routings are memorized. So when pulling the fader to the bottom (maximum attenuation), the individual settings are back when you right click the mouse and pull the fader up. The individual settings get lost in m.a. position as soon as the fader is clicked with the left mouse button. As long as no single level is at m.a. position, the left mouse button can be used to change the current routing's gain.

The checkmarks are un-checked by moving the fader to m.a. This setting deactivates the routing...why route if there is no level? Click onto '7+8' in the routing window, pull the fader down, open the routing window again - the checkmark is gone.

The number of channels is reduced automatically when entering Double Speed mode (96 kHz). The display is adjusted accordingly, and all fader settings remain stored. The same is true for Quad Speed operation (192 kHz) with 16 channels.

25.5 Submix View

Such a wide range of possibilities make it difficult to maintain the overview. Because as shown practically all hardware outputs can be used for different Submixes, (up to 32 completely independent stereo submixes, 16 4-channel submixes etc.). And when opening the routing windows you might see an army of checkmarks, but you don't get an overview, i.e. how the signals come together and where. This problem is solved by **Submix View** mode. In this mode, all routing fields jump to the routing pair just being selected. You can then see immediately, which channels, which fader and pan settings make a submix (for example '1+2'). At the same time the Submix View simplifies setting up the mixer, as all channels can be set simultaneously to the same routing destination with just one click.

Changing to a different destination (output channel) is done in any routing field, or by a click on the desired output pair in the bottom row.

25.6 Mute und Solo

Mute operates pre-fader, thus mutes all currently active routings of the channel. As soon as any Mute button is pressed, the *Mute Master* button lights up in the Quick Access area. With this all selected mutes can be switched off and on again. You can comfortably make mute-groups or activate and deactivate several Mutes simultaneously.

The same holds true for the Solo and the *Solo Master* buttons. As with conventional mixing desks, Solo operates only for the output defined as **Monitor Main**, as a solo-in-place, post fader. As soon as one Solo button is pressed, the *Solo Master* button lights up in the Quick Access area. With this all selected Solos can be switched off and on again. You can comfortably make solo-groups or activate and deactivate several Solos simultaneously.

25.7 The Quick Access Panel

This section includes additional options, further improving the handling of TotalMix. The Master buttons for Mute and Solo have already been described, they allow for group-based working with these functions.

In the **View** section the single mixer rows can be made visible or invisible. If the inputs are not needed for a pristine playback mix, the whole upper row falls out of the picture after a click on the Input button. If the hardware outputs don't interest you either, the window can thus be reduced to the playback channels to save space. All combinations are possible and allowed.

As described earlier, **Submix** sets all routing windows to the same selection. Deactivating Submix automatically recalls the previous view. The mixer can be made smaller horizontally and vertically. This way TotalMix can be made substantially smaller and space-saving on the desktop/screen, if you have to monitor or set only a few channels or level meters.

The **Presets** are one of the most powerful and useful features of TotalMix. Behind the eight buttons, eight files are hidden (see next chapter). These contain the complete mixer state. All faders and other settings follow the changing of preset(s) in real-time, just by a single mouse click. The **Save** button allows for storing the present settings in any preset. You can change back and forth between a signal distribution, complete input monitoring, a stereo and mono mix, and various submixes without any problem.

If any parameter is being altered after loading a preset (e. g. moving a fader), the preset display flashes in order to announce that something has been changed, still showing which state the present mix is based on.

If no preset button is lit, another preset had been loaded via the **File** menu and **Open file**. Mixer settings can be saved the usual way and have long file names.

Instead of single presets a complete bank of (8) presets can be loaded at once. Advantage: The names defined for the preset buttons will be stored and loaded automatically.

Up to three HDSPe MADI can be used simultaneously. The **Unit** buttons switch between the cards. Holding down Ctrl while clicking on button Unit 2 or Unit 3 will open another TotalMix window.



25.8 Presets

TotalMix includes eight factory presets, stored within the program. The user presets can be changed at any time, because TotalMix stores and reads the changed presets from the files **preset11.mad** to **preset81.mad**, located in Windows' hidden directory *Documents and Settings*, <Username>, *Local Settings*, *Application Data*, *RME TotalMix*. On the Mac the location is in the folder *User*, <Username>, *Library / Preferences / Hammerfall DSP*. The first number indicates the current preset, the second number the current unit.

This method offers two major advantages:

- Presets modified by the user will not be overwritten when reinstalling or updating the driver
- The factory presets remain unchanged, and can be reloaded any time.

Mouse: The original factory presets can be reloaded by holding down the Ctrl-key and clicking on any preset button. Alternatively the files described above can be renamed, moved to a different directory, or being deleted.

Keyboard: Using Ctrl and any number between 1 and 8 (not on the numeric keypad) will load the corresponding factory default preset. The key Alt will load the user presets instead.

When loading a preset file, for example 'Main Monitor AN 1_2 plus headphone mix 3_4.mad', the file name will be displayed in the title bar of the TotalMix window. Also when loading a preset by the preset buttons the name of the preset is displayed in the title bar. This way it is always clear what the current TotalMix state is based on.

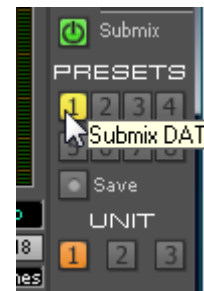

The eight factory presets offer a pretty good base to modify them to your personal needs. In all factory presets Submix View is active by default.

Preset 1

Description: All channels routed 1:1, monitoring of all playback channels.

Details: All inputs maximum attenuation. All playback channels 0 dB, routed to the same output. All outputs 0 dB. Level display set to RMS +3 dB. View Submix active.

Note: This preset is *Default*, offering the standard functionality of a I/O-card.

Preset 2

Description: All channels routed 1:1, input and playback monitoring. As Preset 1, plus 1:1 pass through of all inputs.

Preset 3

Description: All channels routed 1:1, no input and no playback monitoring. All faders set to maximum attenuation.

Preset 4

Description: All channels routed 1:1, input and playback monitoring. As Preset 2, but all inputs muted.

Preset 5

Description: All channels routed 1:1, playback monitoring. Submix of all playback channels to channels 63/64 (phones monitoring). Hardware output 63/64 selected and at -12 dB.

Preset 6

Description: As preset 5, but submix of all input channels to channels 63/64 (phones monitoring).

Preset 7

Description: As preset 5, but submix of all input and playback channels to channels 63/64 (phones monitoring).

Preset 8

Description: Panic. As Preset 4, but playback channels muted too (no output signal).

Preset Banks

Instead of a single preset, all eight presets can be stored and loaded at once. This is done via Menu **File**, **Save All Presets as** and **Open All Presets** (file suffix .mpr). After the loading the presets can be activated by the preset buttons. In case the presets have been renamed (see chapter 25.11), these names will be stored and loaded too.

25.9 The Monitor Panel

The Monitor panel provides several options usually found on analog mixing desks. It offers quick access to monitoring functions which are needed all the time in typical studio work.

Monitor Main

Use the drop down menu to select the hardware outputs where your main monitors are connected to.

Dim

A click on this button will lower the volume of the *Monitor Main* output by an amount set up in the Preferences dialog (see below). This is the same as moving the third row faders down a bit, but much more convenient, as the old setting is back by a simple mouse click.

Mono

Sets the stereo output defined above to monaural playback. Useful to check for mono compatibility and phase problems.

Talkback

A click on this button will dim all signals on the *Monitor Phones* outputs by an amount set up in the Preferences dialog. At the same time the control room's microphone signal (source defined in Preferences) is sent to the three destinations *Monitor Phones* described below. The microphone level is adjusted with the channel's input fader.



Monitor Phones 1/2/3

Use the drop down menu to select the hardware outputs where the submixes are sent to. These submixes are usually phones mixdowns for the musicians. A click on the button allows for the monitoring of the specific submix via the *Monitor Main* output. So when setting up or modifying the submix for the musician this process can be monitored easily and any time.

25.10 Preferences

The dialog box Preferences is available via the menu *Options* or directly via F3.

Talkback

Input: Select the input channel of the Talkback signal (microphone in control room).

Dim: Amount of attenuation of the signals routed to the *Monitor Phones* in dB.

Listenback

Input: Select the input channel of the Listenback signal (microphone in recording room).

Dim: Amount of attenuation of the signals routed to the *Monitor Main* in dB.

Monitor Main

Dim: Amount of attenuation of the Monitor Main output in dB. Activated by the *Dim* button in the Monitor panel.

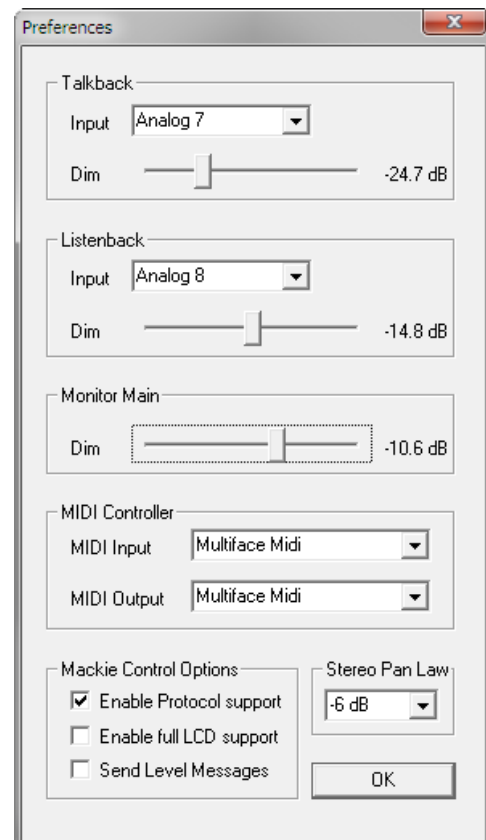

MIDI Controller

MIDI In: Input where TotalMix receives MIDI Remote data.

MIDI Out: Output where TotalMix sends MIDI Remote data.

Mackie Control Options

Enable Protocol Support: When disabled TM FX will only react on the Control Change commands of chapter 28.5.

Enable full LCD support: Activates full Mackie Control LCD support with eight channel names and eight volume/pan values.

Send Level Messages: Activates the transmission of the level meter data.

Stereo Pan Law

The Pan Law can be set to -6 dB, -4.5 dB, -3 dB and 0 dB. The value chosen defines the level attenuation in pan center position. This setting is useful because the ASIO host often supports different pan laws too. Selecting the same value here and in the ASIO host, ASIO Direct Monitoring works perfectly, as both ASIO host and TotalMix use the same pan law. Of course, when not using ADM it can be changed to a setting different from the factory preset of -6 dB as well. You will most probably find that -3 dB gives a much more stable loudness when moving an object between left and right.

25.11 Editing the Names

The channel names shown in the grey label area can be edited. A right mouse click on the grey name field brings up the dialog box **Enter Name**. Any name can be entered in this dialog. Enter/Return closes the dialog box, the grey label now shows the first letters of the new name. ESC cancels the process and closes the dialog box.



Moving the mouse over the label brings up a tool tip with the complete name.

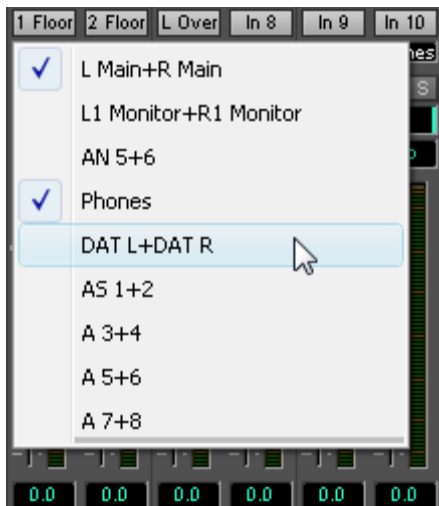

The hardware outputs (third row) can be edited in the same way. In this case, the names in the routing drop down menu will change automatically. Additionally the names in the drop down menu of the Monitor section will change as well.

The preset buttons can get meaningful names in the same way. Move the mouse over a preset button, a right mouse click will bring up the dialog box.

Note that the name shows up as tool tip only, as soon as the mouse stays over the preset button.

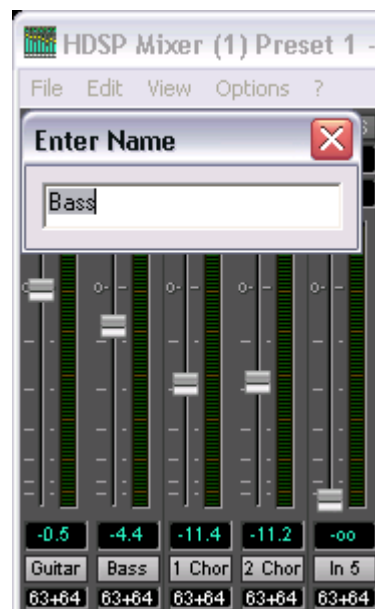

The preset button names are not stored in the preset files, but globally in the registry, so won't change when loading any file or saving any state as preset. But loading a preset bank (see chapter 25.8) the names will be updated.

25.12 Hotkeys

In many situations TotalMix can be controlled quickly and comfortably by the keyboard, making the mixer setup considerably easier and faster. The **Shift**-key for the fine mode for faders and panpots has already been mentioned. The **Ctrl**-key can do far more than changing the routing pairwise:

- Clicking anywhere into the fader area with the Ctrl-key pressed, sets the fader to 0 dB.
- Clicking anywhere into the pan area with the Ctrl-key pressed, sets the panorama to <C> meaning Center.
- Clicking a preset button while holding down Ctrl, the original factory preset will be loaded.
- Using Ctrl and any number between 1 and 8 (not on the numeric keypad!) will load the corresponding factory default preset. Alt plus number loads the user preset.
- Using multiple HDSPe MADI, clicking the button *Unit 2* while holding down Ctrl opens a second TotalMix window for the second HDSP system, instead of replacing the window contents.

The faders can also be moved pairwise, corresponding to the stereo-routing settings. This is achieved by pressing the **Alt**-key and is especially comfortable when setting the SPDIF and Phones output level. Even the panoramas can be operated with Alt, from stereo through mono to inversed channels, and also the Mute and Solo buttons (ganged or inversed switching!).

At the same time, TotalMix also supports combinations of these keys. If you press **Ctrl** and **Alt** at the same time, clicking with the mouse makes the faders jump to 0 dB pairwise, and they can be set pairwise by **Shift-Alt** in fine mode.

Also very useful: the faders have two mouse areas. The first area is the fader button, which can be grabbed at any place without changing the current position. This avoids unwanted changes when clicking onto it. The second area is the whole fader setting area. Clicking into this area makes the fader jump to the mouse at once. If for instance you want to set several faders to m.a., it is sufficient to click onto the lower end of the fader path. Which happens pairwise with the Alt-key pressed.

Using the hotkeys **I**, **O** and **P** the complete row of Input, Playback and Output channels each can be toggled between visible and invisible. Hotkey **S** switches Submix view on/off. Those four hotkeys have the same functionality as the buttons in the **View** section of the Quick Access Panel. The Level Meter Setup dialog can be opened via **F2** (as in DIGICheck). The dialog box Preferences is opened via **F3**.

Hotkey **M** toggles Mute Master on/off (and with this performs a global mute on/off). Hotkey **X** toggles the Matrix view on/off (see chapter 26), hotkey **T** the mixer view. Hotkey **L** links all faders as stereo pairs.

Further hotkeys are available to control the configuration of the Level Meter (see chapter 25.15):

Key **4** or **6**: Display range 40 or 60 dB

Key **E** or **R**: Numerical display showing Peak or RMS

Key **0** or **3**: RMS display absolute or relative to 0 dBFS

25.13 Menu Options

Always on Top: When active (checked) the TotalMix window will always be on top of the Windows desktop.

Note: This function may result in problems with windows containing help text, as the TotalMix window will even be on top of those windows, so the help text isn't readable.

Deactivate Screensaver: When active (checked) any activated Windows screensaver will be disabled temporarily.

Ignore Position: When active, the windows size and position stored in a file or preset will not be used. The routing will be activated, but the window will not change.

Ignore I/O Labels: When active the channel names saved in a preset or file will not be loaded, instead the current ones will be retained.

ASIO Direct Monitoring (Windows only): When de-activated any ADM commands will be ignored by TotalMix. In other words, ASIO Direct Monitoring is globally de-activated.

Link Faders: Selecting this option all faders will be treated as stereo pairs and moved pairwise. Hotkey L.

MS Processing: Macro for a quick configuration of routing and phase for Mid/Side encoding and decoding. See chapter 27.7.

Level Meter Setup: Configuration of the Level Meters. Hotkey F2. See chapter 25.15.

Level Meter Text Color: Colour adjustment for the Gain and Level meter text displays. Default: Hue 110, Saturation 225, Brightness 135.

Preferences: Opens a dialog box to configure several functions, like Pan Law, Dim, Talkback Dim, Listenback Dim. See chapter 25.10.

Enable MIDI Control: Turns MIDI control on. The channels which are currently under MIDI control are indicated by a colour change of the info field below the faders, black turns to yellow.

Deactivate MIDI in Background: Disables the MIDI control as soon as another application is in the focus, or in case TotalMix has been minimized.

Lock Mixer: Opens a dialog box for password entry. Changes on the mixer have no effect anymore until the mixer is unlocked in the same way, by entering the password a second time. The password is stored unencrypted in the registry (Windows: Software, RME, hdspmix, Password).

Undo Load Preset: Turns the mixer state back to the state before the last preset was loaded. This function helps to get back the last mixer setup that was accidentally destroyed by unintentionally loading a preset.

25.14 Menu Fader Groups

TotalMix supports 4 different fader groups. Usage:

- Select faders by clicking on the white name label (turns yellow)
- In the menu click on *Define* – Group X. The level meters below the faders now show GrpX.
- Any group can be activated and deactivated in the menu *Activate*
- Any group can be deleted in the menu *Delete*

25.15 Level Meter

The HDSPe MADI calculates all the display values Peak, Over and RMS in hardware, in order to be capable of using them independent of the software in use, and to significantly reduce the CPU load.

Tip: This feature, the **Hardware Level Meter**, is used by **DIGICheck** (see chapter 15/21) to display Peak/RMS level meters of all channels, nearly without any CPU load.

The level meters integrated in TotalMix - considering their size - cannot be compared with DIGICheck. Nevertheless they already include many useful functions.

Peak and RMS is displayed for every channel. 'Level Meter Setup' (menu Options or F2) and direct keyboard entry (*hotkeys*) make various options available:

- Display range 40 or 60 dB (*hotkey 4 or 6*)
- Release time of the Peak display (Fast/Medium/Slow)
- Numerical display selectable either Peak or RMS (*Hotkey E or R*)
- Number of consecutive samples for Overload display (1 to 15)
- RMS display absolute or relative to 0 dBFS (*Hotkey 3 or 0*)

The latter is a point often overlooked, but nonetheless important. A RMS measurement shows 3 dB less for sine signals. While this is mathematically correct, it is not very reasonable for a level meter. Therefore the RMS readout is usually corrected by 3 dB, so that a full scale sine signal shows 0 dBFS on both Peak and RMS meters.

This setting also yields directly readable signal-to-noise values. Otherwise the value shown with noise is 3 dB better than it actually is (because the reference is not 0 dB, but -3 dB).

The value displayed in the text field is independent of the setting 40/60 dB, it represents the full 24 bit range of the RMS measurement. An example: A *RME ADI-8 QS* connected to the HDSPe MADI's input will show around -114 dBFS on all eight input level meters.



This level display of TotalMix also provides means for a constant monitoring of the signal quality. Thus it can be a valuable tool for sound optimization and error removal in the studio.

 *Measuring SNR (Signal to Noise) is best done with RME's free software DIGICheck. The function Bit Statistic includes three different RMS meters for exactly this purpose (RMS unweighted, A-weighted and DC).*

26. TotalMix: The Matrix

26.1 Overview

The mixer window of TotalMix looks and operates similar to mixing desks, as it is based on a conventional stereo design. The matrix display presents a different method of assigning and routing channels, based on a single channel or monaural design. The matrix view of the HDSP has the looks and works like a conventional patchbay, adding functionality way beyond comparable hardware and software solutions. While most patchbays will allow you to connect inputs to outputs with just the original level (1:1, or 0 dB, as known from mechanical patchbays), TotalMix allows you to use a freely definable gain value per crosspoint.

Matrix and TotalMix are different ways of displaying the same processes. Because of this both views are always fully synchronized. Each change in one view is immediately reflected in the other view as well.

26.2 Elements of the Matrix View

The visual design of the TotalMix Matrix is mainly determined by the architecture of the HDSP system:

- Horizontal labels: All hardware outputs
- Vertical labels: All hardware inputs. Below are all playback channels (software playback channels)
- Green 0.0 dB field: Standard 1:1 routing
- Black gain field: Shows the current gain value as dB
- Orange gain field: This routing is muted.
- Blue field: Phase 180° (inverted)

	1	2	3	4	5
In 1	0.0				
In 2		-5.9			
In 3			0.0		
In 4				0.0	
In 5					0.0
In 6					
In 7					
In 8					
In 9					
In 10					

To maintain overview when the window size has been reduced, the left and upper labels are floating. They won't leave the visible area when scrolling.

26.3 Operation

Using the Matrix is a breeze. It is very easy to identify the current crosspoint, because the outer labels light up in orange according to the mouse position.

If input 1 is to be routed to output 1, use the mouse and click one time on crosspoint **In 1 / 1**. The green 0.0 dB field pops in, another click removes it. To change the gain (equals the use of a different fader position, see simultaneous display of the mixer view), hold Ctrl down and drag the mouse up or down, starting from the gain field. The value within the field changes accordingly. The corresponding fader in the mixer view is moving simultaneously, in case the currently modified routing is visible.

Note the difference between the left side, representing the inputs and software playback channels, and the upper side, representing the hardware outputs. Moving a fader in row 1 or 2 in TotalMix view, only the specific levels (max. 2) of this routing will change within the Matrix. But moving a fader in row 3 will make all vertically activated levels move at once (for example 63/64, analog output).

A gain field marked orange indicates activated mute status. Mute can only be changed in the mixer view.

A blue field indicates phase inversion. This state is displayed in the Matrix only, and can only be changed within the Matrix view. Hold down the Shift-key while clicking on an already activated field. Mute overwrites the phase display, blue becomes orange. If mute is deactivated the phase inversion is indicated again.

26.4 Advantages of the Matrix

The Matrix not always replaces the mixer view, but it significantly enhances the routing capabilities and - more important - is a brilliant way to get a fast overview of all active routings. It shows you in a glance what's going on. And since the Matrix operates monaural, it is very easy to set up specific routings with specific gains.

Example 1: You want TotalMix to route all software outputs to all corresponding hardware outputs, and have a submix of all inputs and software outputs on the Phones output (equals factory preset 2). Setting up such a submix is easy. But how to check at a later time, that all settings are still exactly the way you wanted them to be, not sending audio to a different output?

The most effective method to check a routing in mixer view is the Submix View, stepping through all existing software outputs, and having a very concentrated look at the faders and displayed levels of each routing. That doesn't sound comfortably nor error-free, right? Here is where the Matrix shines. In the Matrix view, you simply see a line from upper left to lower right, all fields marked as unity gain. Plus two rows vertically all at the same level setting. You just need 2 seconds to be sure no unwanted routing is active anywhere, and that all levels match precisely!

Example 2: The Matrix allows you to set up routings which would be nearly impossible to achieve by fiddling around with level and pan. Let's say you want to send input 1 to output 1 at 0 dB, to output 2 at -3 dB, to output 3 at -6 dB and to output 4 at -9 dB. Each time you set up the right channel (2/4), the change in pan destroys the gain setting of the left channel (1/2). A real hassle! In Matrix view, you simply click on the corresponding routing point, set the level via Ctrl-mouse, and move on. You can see in TotalMix view how pan changes to achieve this special gain and routing when performing the second (fourth...) setting.

27. TotalMix Super-Features

27.1 ASIO Direct Monitoring (Windows only)

Start Samplitude, Sequoia, Cubase or Nuendo and TotalMix. Activate ADM (ASIO Direct Monitoring), and move a fader in the ASIO host. Now watch the corresponding fader in TotalMix magically move too. TotalMix reflects all ADM gain and pan changes in real-time. Please note that faders only move when the currently activated routing (currently visible routing) corresponds to the one in the ASIO host. Also note that the Matrix will show any change, as it shows all possible routings in one view.

With this TotalMix has become a wonderful debugging tool for ADM. Just move the host's fader and pan, and see what kind of ADM commands TotalMix receives.

The hardware output row faders are included in all gain calculations, in every possible way. Example: you have lowered the output level of a submix, or just a specific channel, by some dB. The audio signal passed through via ADM will be attenuated by the value set in the third row.

27.2 Selection and Group-based Operation

Click on the grey name label of channel 1 and 2 in TotalMix. Be sure to have channel 3's fader set to a different position and click on its label too. All three labels have changed to the colour orange, which means they are *selected*. Now moving any of these faders will make the other faders move too. This is called 'building a group of faders', or ganging faders, maintaining their relative position.

Building groups or ganging can be done in any row, but is limited to operate horizontally within one row. If you usually don't need this, you can at least gang the analog outputs. The advantage over holding the Alt-key is that Alt sets both channels to the same level (can be handy too), while grouping via selection will retain any offset (if you need one channel to be louder all the time etc.).

Note: The relative positions are memorized until the faders are pulled down so that they reach upper or lower maximum position *and* the group is changed (select another channel or deselect one of the group).

27.3 Copy Routings to other Channels

TotalMix allows to copy complete routing schemes of inputs and outputs.

Example 1: You have input 5 (guitar) routed within several submixes/hardware outputs (= headphones). Now you'll get another input with keyboards that should appear in the same way on all headphones. Select input 5, open the menu *Edit*. It shows 'Copy In 5'. Now select the desired new input, for example In 8. The menu now shows 'Paste In 5 to In 8'. Click on it - done. If you are familiar with this functionality just use Ctrl-C and Ctrl-V. Else the self updating menu will always let you know what actually will happen.

Tip: Have the Matrix window open as second window when doing this. It will show the new routings immediately, so copying is easier to understand and to follow.

Example 2: You have built a comprehensive submix on outputs 4/5, but now need the exact same signal also on the outputs 6/7. Click on Out 4, Ctrl-C, click on Out 6, Ctrl-V, same with 5/7 - you're done!

The Matrix shows you the difference between both examples. Example 1 means copying lines (horizontally), while example 2 means copying rows (vertically).

Example 3: Let's say the guitarist finished his recording, and you now need the same signal again on all headphones, but this time it comes from the recording software (playback row). No problem, you can even copy between rows 1 and 2 (copying between row 3 and 1/2 isn't possible).

But how to select while a group is active? De-selecting the group first? Not necessary! TotalMix always updates the copy and paste process with the *last* selection. This way you don't have to de-activate any group-selections when desiring to perform a copy and paste action.

27.4 Delete Routings

The fastest way to delete complex routings: select a channel in the mixer view, click on the menu entry *Edit* and select *Delete*. Or simply hit the Del-key. Attention: there is no undo in TotalMix, so be careful with this function!

27.5 Recording a Subgroup (Loopback)

TotalMix supports a routing of the subgroup outputs (=hardware outputs, bottom row) to the recording software. Instead of the signal at the hardware input, the signal at the hardware output is sent to the record software. This way, complete submixes can be recorded without an external loopback cable. Also the playback of a software can be recorded by another software.

To activate this function, click on the grey label in the third row while holding down the Ctrl-key. The label's colour changes to red. In case the channel has already been part of a group, the colour will change from yellow to orange, signalling that the group functionality is still active for this channel.

In loopback mode, the signal at the hardware input of the corresponding channel is no longer sent to the recording software, but still passed through to TotalMix. Therefore TotalMix can be used to route this input signal to any hardware output. Using the subgroup recording, the input can still be recorded on a different channel.

As each of the 64 hardware outputs can be routed to the record software, and none of these hardware inputs get lost, TotalMix offers an overall flexibility and performance not rivalled by any other solution.

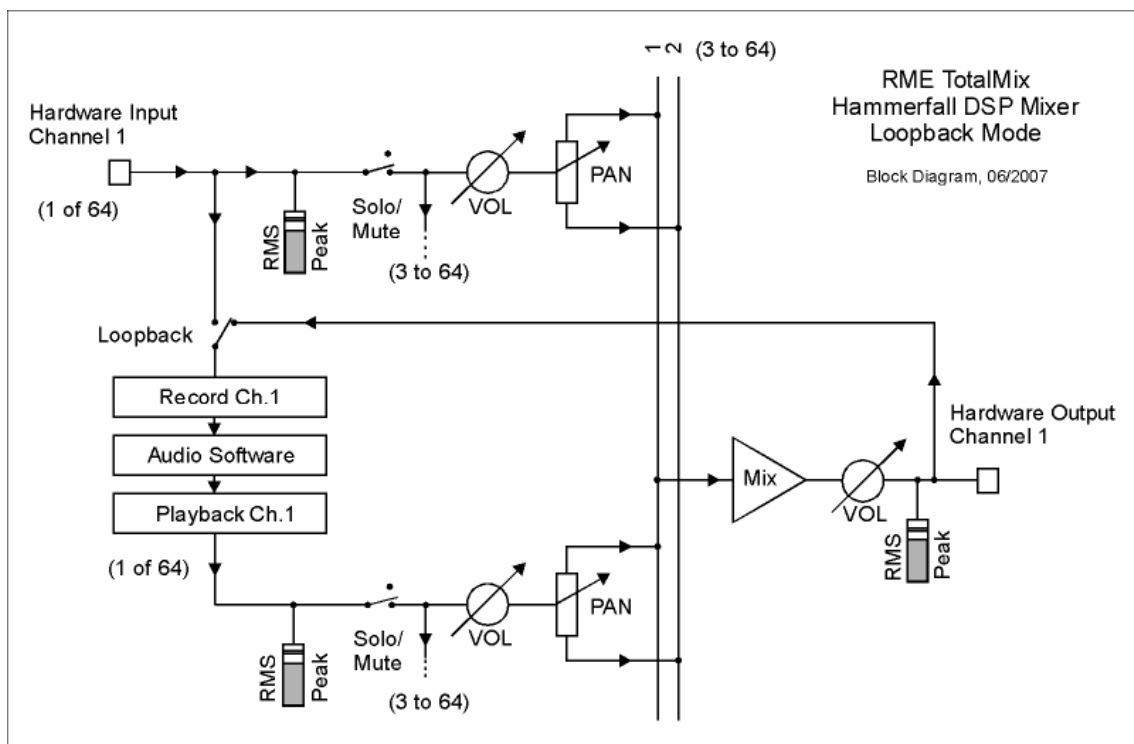

Additionally the risk of feedbacks, a basic problem of loopback methods, is highly reduced, because the feedback can not happen within the mixer, but only when the audio software is switched into monitoring mode. The block diagram shows how the software's input signal is played back, and fed back from the hardware output to the software input. A software monitoring on the subgroup record channels is only allowed as long as the monitoring is routed in both software and TotalMix to a different channel than the active subgroup recording one.

Recording a Software's playback

In real world application, recording a software's output with another software will show the following problem: The record software tries to open the same playback channel as the playback software (already active), or the playback one has already opened the input channel which should be used by the record software.

This problem can easily be solved. First make sure that all rules for proper multi-client operation are met (not using the same record/playback channels in both programs). Then route the playback signal via TotalMix to a hardware output in the range of the record software, and activate it via Ctrl-mouse for recording.

Mixing several input signals into one record channel

In some cases it is useful to record several sources in only one track. For example when using two microphones when recording instruments and loudspeakers. TotalMix' Loopback mode saves an external mixing desk. Simply route/mix the input signals to the same output (third row), then re-define this output into a record channel via Ctrl-mouse – that's it. This way any number of input channels from different sources can be recorded into one single track.

27.6 Using external Effects Devices

With TotalMix a usage of external hardware - like effects devices - is easy and flexible.

Example 1: The singer (microphone input channel 1) shall have some reverb on his headphones (outputs 11/12). A direct routing In 1 to Out 11/12 for monitoring had been set up already. The external reverb is connected to a free output, for example channel 8. In active mode Submix View click on channel 8 in the bottom row. Drag the fader of input 1 to about 0 dB and the panorama fully to the right. Adjust the input level at the reverb unit to an optimal setting. Next the output of the reverb unit is connected to a free stereo input, for example 5/6. Use the TotalMix level meters to adjust a matching output level at the reverb unit. Now click on channels 11/12 in the bottom row, and move the fader of inputs 5/6 until the reverb effect gets a bit too loud in the headphones. Now click on channel 8 in the bottom row again and drag fader 1 down a bit until the mix of original signal and reverb is perfect for the singer.

The described procedure is completely identical to the one when using an analog mixing desk. There the signal of the singer is sent to an output (usually labelled Aux), from there to a reverb unit, sent back from the reverb unit as stereo wet signal (no original sound), back in through a stereo input (e.g. Effect return) and mixed to the monitoring signal. The only difference: The Aux sends on mixing desks are post-fader. Changing the level of the original signal causes a change of the effects level (here the reverb) too, so that both always have the same ratio.

Tip: Such a functionality is available in TotalMix via the right mouse button! Dragging the faders by use of the right mouse button causes all routings of the current input or playback channel to be changed in a relative way. This completely equals the function **Aux post fader**.

Example 2: Inserting an effects device can be done as above, even within the record path. Other than in the example above the reverb unit also sends the original signal, and there is no routing of input 1 directly to outputs 11/12. To insert an effects device like a Compressor/Limiter directly into the record path, the input signal of channel 1 is sent by TotalMix to any output, to the Compressor, back from the Compressor to any input. This input is now selected within the record software.

Unfortunately, very often it is not possible within the record software to assign a different input channel to an existing track 'on the fly'. The loopback mode solves this problem elegantly. The routing scheme stays the same, with the input channel 10 sent to any output via TotalMix, to the Compressor, from the Compressor back to any input. Now this input signal is routed directly to output 10, and output 10 is then switched into loopback mode via Ctrl-mouse.

As explained in chapter 27.5, the hardware input of channel 10 now no longer feeds the record software, but is still connected to TotalMix (and thus to the Compressor). The record software receives the signal of submix channel 10 instead – the Compressor's return path.

27.7 MS Processing

The mid/side principle is a special positioning technique for microphones, which results in a mid signal on one channel and a side signal on the other channel. These information can be transformed back into a stereo signal quite easily. The process sends the monaural mid channel to left and right, the side channel too, but phase inverted (180°) to the right channel. For a better understanding: the mid channel represents the function L+R, while the side channel represents L-R.

During record the monitoring needs to be done in 'conventional' stereo. As TotalMix can invert the phase, it also offers the functionality of a M/S-decoder. The menu *Options* includes a macro to simplify the setup. First select the two input channels, in the picture to the right *MADI In 3* and *4*, having the current routing destination *MADI Out 1+2*. Now the string *MS Processing In 3+4 to AN 1+2 On* is shown in *Options*.

	AN 1	AN 2	AN 3
In 1			
In 2			
In 3	-6.0	-6.0	
In 4	-6.0	-6.0	
In 5			
In 6			
In 7			

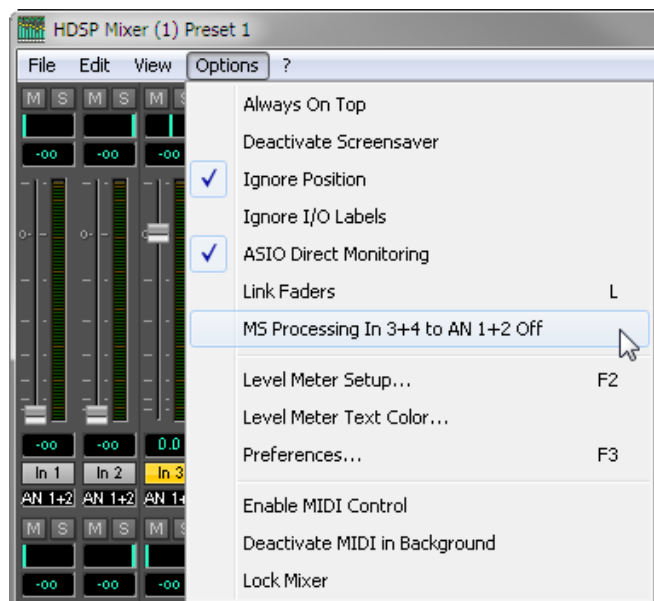

After a mouse click TotalMix sets gains and pans correctly. Of course these settings can also be performed manually. Repeat the last step to remove all routings (*menu Options ...Off*).

The M/S-Processing automatically operates as M/S encoder or decoder, depending on the source signal format. When processing a usual stereo signal, all monaural information will be shifted into the left channel, all stereo information into the right channel. Thus the stereo signal is M/S encoded. This yields some interesting insights into the mono/stereo contents of modern music productions. Additionally some very interesting methods of manipulating the stereo base and generating stereo effects come up, as it is then very easy to process the side channel with Low Cut, Expander, Compressor or Delay. The most basic application is already available directly in TotalMix: Changing the level of the side channel allows to manipulate the stereo width from mono to stereo up to extended, stepless and in real-time.

28. TotalMix MIDI Remote Control

28.1 Overview

TotalMix can be remote controlled via MIDI. It is compatible to the widely spread Mackie Control protocol, so TotalMix can be controlled with all hardware controllers supporting this standard. Examples are the Mackie Control, Tascam US-2400 or Behringer BCF 2000.

Additionally, the stereo output faders (lowest row) which are set up as *Monitor Main* outputs in the Monitor panel can also be controlled by the standard **Control Change Volume** via **MIDI channel 1**. With this, the main volume of the HDSPe MADI is controllable from nearly any MIDI equipped hardware device.

28.2 Mapping

TotalMix supports the following Mackie Control surface elements*:

Element:	Meaning in TotalMix:
Channel faders 1 – 8	volume
Master fader	Main Monitor channel's faders
SEL(1-8) + DYNAMICS	reset fader to Unity Gain
V-Pots 1 – 8	pan
pressing V-Pot knobs	pan = center
CHANNEL LEFT or REWIND	move one channel left
CHANNEL RIGHT or FAST FORWARD	move one channel right
BANK LEFT or ARROW LEFT	move eight channels left
BANK RIGHT or ARROW RIGHT	move eight channels right
ARROW UP or Assignable1/PAGE+	move one row up
ARROW DOWN or Assignable2/PAGE-	move one row down
EQ	Master Mute
PLUGINS/INSERT	Master Solo
STOP	Dim Main Monitor
PLAY	Talkback
PAN	Mono Main Monitor
MUTE Ch. 1 – 8	Mute
SOLO Ch. 1 – 8	Solo
SELECT Ch. 1 – 8	Select
REC Ch. 1 – 8	in Submix mode only: select output bus
F1 - F8	load preset 1 - 8
F9	select Main Monitor
F10 - F12	Monitor Phones 1 - 3

*Tested with Behringer BCF2000 Firmware v1.07 in Mackie Control emulation for Steinberg mode and with Mackie Control under Mac OS X.

28.3 Setup

- Open the Preferences dialog (menu Options or F3). Select the MIDI Input and MIDI Output port where your controller is connected to.
- When no feedback is needed (when using only standard MIDI commands instead of Mackie Control protocol) select NONE as MIDI Output.
- Check *Enable MIDI Control* in the Options menu.

28.4 Operation

The channels being under MIDI control are indicated by a colour change of the info field below the faders, black turns to yellow.

The 8-fader block can be moved horizontally and vertically, in steps of one or eight channels.

Faders can be selected to gang them.

In Submix View mode, the current routing destination (output bus) can be selected via REC Ch. 1 – 8. This equals the selection of a different output channel in the lowest row by a mouse click when in Submix View. In MIDI operation it is not necessary to jump to the lowest row to perform this selection. This way even the routing can be easily changed via MIDI.

Full LC Display Support. This option in Preferences (F3) activates complete Mackie Control LCD support with eight channel names and eight volume/pan values.



Attention: this feature causes heavy traffic on the MIDI port when ganging more than 2 faders! In such a case, or when using the Behringer BCF2000, turn off this option.

When *Full LC Display Support* is turned off, only a brief information about the first fader of the block (channel and row) is sent. This brief information is also available on the LED display of the Behringer BCF2000.

Deactivate MIDI in Background (menu Options) disables the MIDI control as soon as another application is in the focus, or in case TotalMix has been minimized. This way the hardware controller will control the main DAW application only, except when TotalMix is in the foreground. Often the DAW application can be set to become inactive in background too, so that MIDI control is switched between TotalMix and the application automatically when switching between both applications.

TotalMix also supports the 9th fader of the Mackie Control. This fader (labelled Master) will control the stereo output faders (lowest row) which are set up as *Main Monitor* outputs in the Monitor panel.

28.5 Simple MIDI Control

The stereo output faders (lowest row) which are set up as *Monitor Main* outputs in the Monitor panel can also be controlled by the standard **Control Change Volume** via **MIDI channel 1**. With this, the main volume of the HDSPe MADI is controllable from nearly any MIDI equipped hardware device.

Even if you don't want to control all faders and pans, some buttons are highly desired to be available in 'hardware'. These are mainly the *Talkback* and the *Dim* button, and the new monitoring options (listen to Phones submixes). Fortunately a Mackie Control compatible controller is not required to control these buttons, as they are steered by simple Note On/Off commands on MIDI channel 1.

The notes are (hex / decimal / keys):

Monitor Main: 3E / 62 / **D 4**

Dim: 5D / 93 / **A 6**

Mono: 2A / 42 / **#F 2**

Talkback: 5E / 94 / **#A 6**

Monitor Phones 1: 3F / 63 / **#D 4**

Monitor Phones 2: 40 / 64 / **E 4**

Monitor Phones 3: 41 / 65 / **F 4**

Preset 1: 36 / 54 / **#F 3**

Preset 2: 37 / 55 / **G 3**

Preset 3: 38 / 56 / **#G 3**

Preset 4: 39 / 57 / **A 3**

Preset 5: 3A / 58 / **#A 3**

Preset 6: 3B / 59 / **B 3**

Preset 7: 3C / 60 / **C 4**

Preset 8: 3D / 61 / **#C 4**

Note: Switching off Mackie Protocol support in *Settings / Mackie Control Options* will also disable the above simple MIDI note commands, as they are part of the Mackie protocol.

Furthermore all faders of all three rows can be controlled via simple **Control Change** commands. The format for the Control Change commands is:

The format for the Control Change commands is:

Bx yy zz

x = MIDI channel

yy = control number

zz = value

The first row in TotalMix is addressed by MIDI channels 1 up to 4, the middle row by channels 5 up to 8 and the bottom row by channels 9 up to 12.

16 Controller numbers are used: 102 up to 117 (= hex 66 up to 75). With these 16 Controllers (= faders) and 4 MIDI channels each per row, up to 64 faders can be controlled per row (as required by the HDSPe MADI).

Examples for sending MIDI strings*:

- Set input 1 to 0 dB: B0 66 40
- Set input 17 to maximum attenuation: B1 66 0
- Set playback 1 to maximum: B4 66 7F
- Set Output 16 to 0 dB: B8 75 40

*Note: Sending MIDI strings requires the use of programmer's logic for the MIDI channel, starting with 0 for channel 1 and ending with 15 for channel 16.

28.6 Loopback Detection

The Mackie Control protocol requires feedback of the received commands, back to the hardware controller. So usually TotalMix will be set up with both a MIDI input and MIDI output. Unfortunately any small error in wiring and setup will cause a MIDI feedback loop here, which then completely blocks the computer (the CPU).

To prevent the computer from freezing, TotalMix sends a special MIDI note every 0.5 seconds to its MIDI output. As soon as it detects this special note at the input, the MIDI functionality is disabled. After fixing the loopback, check *Enable MIDI Control* under Options to reactivate the TotalMix MIDI.



User's Guide



HDSPe MADI

▶ **Technical Reference**

29. Technical Specifications

29.1 Inputs

MADI

- Coaxial via BNC, 75 Ohm, according to AES10-1991
- High-sensitivity input stage (< 0.2 Vpp)
- Optical via FDDI duplex SC connector
- 62.5/125 and 50/125 compatible
- Accepts 56 channel and 64 channel mode, plus 96k Frame
- Standard: up to 64 channels 24 bit 48 kHz
- S/MUX: up to 32 channels 24 bit 96 kHz
- S/MUX4: up to 16 channels 24 bit 192 kHz
- Lock range: 25 kHz – 54 kHz
- Jitter when synced to input signal: < 1 ns

Word Clock

- BNC, not terminated (10 kOhm)
- Switch for internal termination 75 Ohm
- Automatic Double/Quad Speed detection and conversion to Single Speed
- SteadyClock guarantees super low jitter synchronization even in varispeed operation
- Not effected by DC-offsets within the network
- Signal Adaptation Circuit: signal refresh through auto-center and hysteresis
- Overvoltage protection
- Level range: 1.0 Vss – 5.6 Vpp
- Lock range: 28 kHz – 200 kHz
- Jitter when synced to input signal: < 1 ns
- Jitter suppression: > 30 dB (2.4 kHz)

29.2 Outputs

MADI

- Coaxial via BNC, 75 Ohm, according to AES10-1991
- Output voltage 600 mVpp
- Cable length: up to 100 m
- Optical via FDDI duplex SC connector
- 62.5/125 and 50/125 compatible
- Cable length: up to 2000 m
- Generates 56 channel and 64 channel mode, plus 96k Frame
- Standard: up to 64 channels 24 bit 48 kHz
- S/MUX / 96k Frame: up to 32 channels 24 bit 96 kHz
- S/MUX4: up to 16 channels 24 bit 192 kHz

Word Clock

- 2 x BNC, separated driver stage
- Max. output voltage: 5 Vpp
- Output voltage @ 75 Ohm termination: 4.0 Vpp
- Output impedance: 10 Ohm
- Frequency range: 28 kHz – 200 kHz

Stereo Monitor Output (Phones)

- Signal to Noise ratio (SNR): 115 dB RMS unweighted, 118 dBA @ 44.1 kHz (unmuted)
- THD: < -104 dB, < 0.00063 %
- THD+N: < -102 dB, < 0.0008 %
- Crosstalk: > 100 dB
- Frequency response @ 44.1 kHz, -0.5 dB: 5 Hz – 22 kHz
- Frequency response @ 96 kHz, -0.5 dB: 5 Hz – 45.9 kHz
- Frequency response @ 192 kHz, -1 dB: 5 Hz – 66.5 kHz
- Output: 6.3 mm / 1/4" TRS jack
- Output impedance: 75 Ohm
- Output level @ 0 dBFS: +13 dBu

29.3 Digital

- Clocks: Internal, MADI In, Word Clock In, optional Video and LTC In
- Low jitter design: < 1 ns in PLL mode, all inputs
- Internal clock: 800 ps jitter, random spread spectrum
- Jitter suppression of external clocks: about 30 dB (2.4 kHz)
- Effective clock jitter influence on DA conversion: near zero
- Provides nearly jitter-free word clock directly from the MADI input signal
- Input PLL ensures zero dropout, even at more than 100 ns jitter
- Supported sample rates: 28 kHz up to 200 kHz

- Compliant with PCI Express Base Specification v1.1
- 1-Lane PCI Express Endpoint device (no PCI Express to PCI Bridge)
- 2.5 Gbps line speed
- Packet-based full-duplex communication (up to 500 MB/s transfer rate)

29.4 MIDI

- 2 x MIDI I/O via breakout cable
- 1 x MIDI I/O via MADI
- PCIe bus based hi-speed operation
- Separate 128 byte FIFO for input and output
- MIDI state machine in hardware for reduced interrupt request load
- Invisible transmission via User bit of channel 56 (up to 48 kHz)
- Invisible transmission via User bit of channel 28 (up to 96 kHz)

30. Technical Background

30.1 MADl Basics

MADl, the serial **M**ultichannel **A**udio **D**igital **I**nterface, has been defined already in 1989 as an extension of the existing AES3 standard following several manufacturers' wish. The format also known as AES/EBU, a balanced bi-phase signal, is limited to two channels. Simply put, MADl contains 28 of those AES/EBU signals in serial, i. e. after one another, and the sample rate can still even vary by +/-12.5%. The limit which cannot be exceeded is a data rate of 100Mbit/s.

Because an exact sampling frequency is used in most cases, the 64 channel mode was introduced officially in 2001. It allows for a maximum sample rate of 48 kHz + ca. 1%, corresponding to 32 channels at 96 kHz, without exceeding the maximum data rate of 100 Mbit/s. The effective data rate of the port is 125 Mbit/s due to additional coding.

Older devices understand and generate only the 56 channel format. Newer devices often work in the 64 channel format, but offer still no more than 56 audio channels. The rest is being eaten up by control commands for mixer settings etc. RME's devices of the MADl series show that this can be done in a much better way, with an invisible transmission of 16 MIDI channels and the MADl signal still being 100% compatible.

For the transmission of the MADl signal, proved methods known from network technology were applied. Most people know unbalanced (coaxial) cables with 75 Ohms BNC plugs, they are not expensive and easy to get. The optical interface is much more interesting due to its complete galvanic separation, but for many users it is a mystery, because very few have ever dealt with huge cabinets full of professional network technology. Therefore here are some explanations regarding 'MADl optical'.

- The cables used are standard in computer network technology. They are thus not at all expensive, but unfortunately not available in every computer store.
- The cables have an internal fibre of only 50 or 62.5 µm diameter and a coating of 125 µm. They are called network cables 62.5/125 or 50/125, the former mostly being blue and the latter mostly being orange. Although in many cases not clearly labelled, these are always (!) glass fibre cables. Plastic fibre cables (POF, plastic optical fibre) can not be manufactured in such small diameters.
- The plugs used are also an industry standard and called SC. Please don't mix them up with ST connectors, which look similar to BNC connectors and are being screwed. Plugs used in the past (MIC/R) were unnecessarily big and are not being used any longer.
- The cables are available as a duplex variant (2 cables being glued together) or as a simplex variant (1 cable). The HDSPe's opto module supports both variants.
- The transmission uses the multimode technique which supports cable lengths of up to almost 2 km. Single mode allows for much longer distances, but it uses a completely different fibre (8 µm). By the way, due to the wave-length of the light being used (1300 nm) the optical signal is invisible to the human eye.

30.2 Lock and SyncCheck

Digital signals consist of a carrier and the data. If a digital signal is applied to an input, the receiver has to synchronize to the carrier clock in order to read the data correctly. To achieve this, the receiver uses a PLL (Phase Locked Loop). As soon as the receiver meets the exact frequency of the incoming signal, it is locked. This **Lock** state remains even with small changes of the frequency, because the PLL tracks the receiver's frequency.

If a MADI signal is applied to the HDSPe MADI, the unit indicates LOCK, i. e. a valid input signal. This information is presented in the HDSPe MADI's Settings dialog. In the status display *SyncCheck*, the state of all clocks is decoded and shown as simple text (No Lock, Lock, Sync).

Unfortunately, LOCK does not necessarily mean that the received signal is correct with respect to the clock which processes the read out of the embedded data. Example: The HDSPe MADI is set to 44.1 kHz internally (clock mode Master), and a mixing desk with MADI output is connected to the card's MADI input. The status display will show LOCK immediately, but usually the mixing desk's sample rate is generated internally (it is Master too), and thus slightly higher or lower than the HDSPe MADI's internal sample rate. Result: When reading out the data, there will frequently be read errors that cause clicks and drop outs.

Also when using multiple clock signals, a simple LOCK is not sufficient. The above described problem can be solved elegantly by setting the HDSPe MADI from Master to AutoSync (its internal clock will then be the clock delivered by the mixing desk). But in case the card is clocked to word clock, this signal can also be un-synchronous, and there will again be a slight difference in the sample rate, and therefore clicks and drop outs.

In order to display those problems, the HDSPe MADI includes **SyncCheck**[®]. It checks all clocks used for *synchronicity*. If they are not synchronous to each other, the status display will show LOCK. If they are synchronous to each other (i.e. absolutely identical), the status display will change to SYNC. In the example above it would have been obvious immediately that the entry LOCK is shown in *SyncCheck* instead of SYNC, right after connecting the mixing desk. With external synchronisation via word clock, both entries Word Clock and MADI must display SYNC.

In practice, SyncCheck allows for a quick overview of the correct configuration of all digital devices. So one of the most difficult and error-prone topics of the digital studio world finally becomes easy to handle.

30.3 Latency and Monitoring

The term **Zero Latency Monitoring** has been introduced by RME in 1998 for the DIGI96 series of audio cards. It stands for the ability to pass-through the computer's input signal at the interface directly to the output. Since then, the idea behind has become one of the most important features of modern hard disk recording. In the year 2000, RME published two ground-breaking Tech Infos on the topics *Low Latency Background*, which are still up-to-date: *Monitoring, ZLM and ASIO*, and *Buffer and Latency Jitter*, both found on the RME website.

How much Zero is Zero?

From a technical view there is no zero. Even the analog pass-through is subject to phase errors, equalling a delay between input and output. However, delays below certain values can subjectively be claimed to be a zero-latency. This applies to analog routing and mixing, and in our opinion also to RME's Zero Latency Monitoring. The term describes the digital path of the audio data from the input of the interface to its output. RME's digital receivers operate buffered, and together with TotalMix and the output via the transmitter cause a typical delay of 3 samples. At 44.1 kHz this equals about 68 μ s (0.000068 s), and about 15 μ s at 192 kHz.

Oversampling

While the delays of digital interfaces can be disregarded altogether, the analog inputs and outputs do cause a significant delay. Modern converter chips operate with 64 or 128 times oversampling plus digital filtering, in order to move the error-prone analog filters away from the audible frequency range as far as possible. This typically generates a delay of one millisecond. A playback and re-record of the same signal via DA and AD (loopback) then causes an offset of the newly recorded track of about 2 ms.

Low Latency!

The HDSPe MADi uses a hi-class DA-converter from Cirrus Logic, offering exceptional Signal to Noise and distortion figures and an innovative digital filter. The exact delays caused by the DA-conversion are:

Sample frequency kHz	44.1	48	88.2	96	176.4	192
DA (10 x 1/fs) ms	0.22	0.2				
DA (5 x 1/fs) ms			0.056	0.052		
DA (5 x 1/fs) ms					0.028	0.026

Buffer Size (Latency)

Windows: This option found in the Settings dialog defines the size of the buffers for the audio data used in ASIO and WDM (see chapter 11 and 13).

Mac OS X: The buffer size is defined within the application. Only some do not offer any setting. For example iTunes is fixed to 512 samples.

General: A setting of 64 samples at 44.1 kHz causes a latency of 1.5 ms, for record and playback each. But when performing a digital loopback test no latency/offset can be detected. The reason is that the software naturally knows the size of the buffers, therefore is able to position the newly recorded data at a place equalling a latency-free system.

AD/DA Offset under ASIO and OS X: ASIO (Windows) and Core Audio (Mac OS X) allow for the signalling of an offset value to correct buffer independent delays, like AD- and DA-conversion or the Safety Buffer described below. An analog loopback test will then show no offset, because the application shifts the recorded data accordingly.

Because the HDSPe MADI is a completely digital interface, and the delays introduced by external AD/DA-converters or other digital interfaces are unknown to unit and driver, the drivers include the digital offset values (3 / 6 / 12 samples). Therefore the delays caused by external converters have to be taken care off in the record software, which usually means that the user has to enter specific offset values manually.

Note: Cubase and Nuendo display the latency values signalled from the driver separately for record and playback. The current driver includes a safety offset of 32 samples for the playback side only, which will be included in the shown value.

Core Audios Safety Offset

Under OS X, every audio interface has to use a so called *safety offset*, otherwise Core Audio won't operate click-free. The HDSPe MADI uses a safety offset of 32 samples. This offset is signalled to the system, and the software can calculate and display the total latency of buffer size plus offset plus safety offset for the current sample rate.

30.4 DS - Double Speed

When activating the *Double Speed* mode the HDSPe MADI operates at double sample rate. The internal clock 44.1 kHz turns to 88.2 kHz, 48 kHz to 96 kHz. The internal resolution is still 24 bit.

Sample rates above 48 kHz were not always taken for granted, and are still not widely used because of the CD format (44.1 kHz) dominating everything. Before 1998 there were no receiver/transmitter circuits available that could receive or transmit more than 48 kHz. Therefore a work-around was used: instead of two channels, one AES line only carries one channel, whose odd and even samples are being distributed to the former left and right channels. By this, you get the double amount of data, i. e. also double sample rate. Of course in order to transmit a stereo signal two AES/EBU ports are necessary then.

This transmission mode is called *Double Wire* in the professional studio world, and is also known as *S/MUX* (abbreviation for *Sample Multiplexing*) in connection with the multichannel ADAT format. The AES3 specification uses the uncommon term *Single channel double sampling frequency mode*.

Not before February 1998, Crystal shipped the first 'single wire' receiver/transmitters that could also work with double sample rate. It was then possible to transmit two channels of 96 kHz data via one AES/EBU port.

But *Double Wire* is still far from being dead. On one hand, there are still many devices which can't handle more than 48 kHz, e. g. digital tape recorders. But also other common interfaces like ADAT or TDIF are still using this technique.

With MADI, sample multiplexing is often used as well to offer sample rates higher than 48 kHz. The HDSPe MADI supports all formats. 96 kHz can be received and transmitted both as 48K Frame (using S/MUX) and as native 96K Frame. In 48K Frame Double Speed mode, the HDSPe MADI distributes the data of one channel to two consecutive MADI channels. This reduces the available channel count from 64 to 32.

As the transmission of double rate signals with 48K Frame is done at standard sample rate (Single Speed), the MADI ports still operate at 44.1 kHz or 48 kHz.

30.5 QS – Quad Speed

Due to the small number of available devices that use sample rates up to 192 kHz, but even more due to a missing real world application (CD...), Quad Speed has had no broad success so far. An implementation of the ADAT format as double S/MUX (S/MUX4) results in only two channels per optical output. Devices using this method are few.

In earlier times the transmission of 192 kHz had not been possible via Single Wire, so once again sample multiplexing was used: instead of two channels, one AES line transmits only one half of a channel. A transmission of one channel requires two AES/EBU lines, stereo requires even four. This transmission mode is being called *Quad Wire* in the professional studio world. The AES3 specification does not mention Quad Wire.

With MADI, sample multiplexing is used as well to offer sample rates higher than 96 kHz. In fact, technical reasons require to use this method beyond 96 kHz. A 192K or 384K Frame format would not be fully compatible to the MADI standard. Therefore 192 kHz is supported as S/MUX4 only. So in 48K Frame Quad Speed mode, a MADI device distributes the data of one channel to four consecutive MADI channels. This reduces the available channel count from 64 to 16.

As the transmission of quad rate signals with 48K Frame is done at standard sample rate (Single Speed), the MADI ports still operate at 44.1 kHz or 48 kHz.

30.6 SteadyClock

The SteadyClock technology of the HDSPe MADI guarantees an excellent performance in all clock modes. Its highly efficient jitter suppression refreshes and cleans up any clock signal, and provides it as reference clock at the word clock output.

Usually a clock section consists of an analog PLL for external synchronization and several quartz oscillators for internal synchronisation. SteadyClock requires only one quartz, using a frequency not equalling digital audio. Latest circuit designs like hi-speed digital synthesizer, digital PLL, 100 MHz sample rate and analog filtering allow RME to realize a completely newly developed clock technology, right within the FPGA at lowest costs. The clock's performance exceeds even professional expectations. Despite its remarkable features, SteadyClock reacts quite fast compared to other techniques. It locks in fractions of a second to the input signal, follows even extreme varipitch changes with phase accuracy, and locks directly within a range of 25 kHz up to 200 kHz.

SteadyClock has originally been developed to gain a stable and clean clock from the heavily jittery MADI data signal. The embedded MADI clock suffers from about 80 ns jitter, caused by the time resolution of 125 MHz within the format. Common jitter values for other devices are 5 ns, while a very good clock will have less than 2 ns.

The picture to the right shows the MADI input signal with 80 ns of jitter (top graph, yellow). Thanks to SteadyClock this signal turns into a clock with less than 2 ns jitter (lower graph, blue).

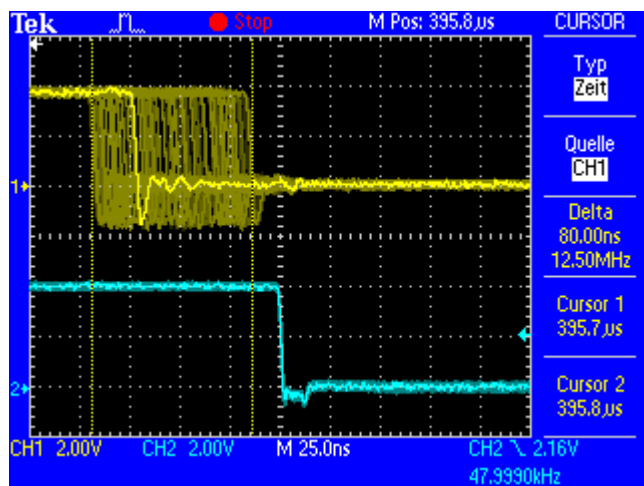

The other input sources of the HDSPe MADI, word clock, Video and LTC, gain a lot from SteadyClock as well. In fact, extracting a low jitter clock from LTC is not possible without a SteadyClock similar technique at all!

The screenshot to the right shows an extremely jittery word clock signal of about 50 ns jitter (top graph, yellow). Again SteadyClock provides an extreme clean-up. The filtered clock shows less than 2 ns jitter (lower graph, blue).

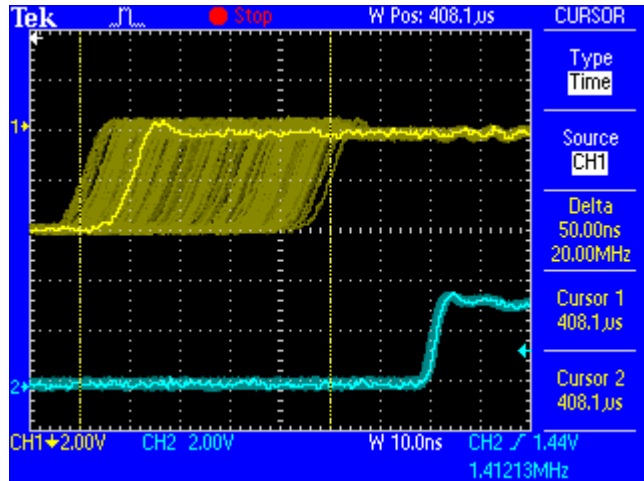

The cleaned and jitter-free signal can be used as reference clock for any application, without any problem. The signal processed by SteadyClock is of course not only used internally, but also available at the HDSPe MADI's word clock outputs. It is also used to clock the digital MADI output.

30.7 Terminology

Single Speed

Sample rate range originally used in Digital Audio. Typical applications are 32 kHz (digital radio broadcast), 44.1 kHz (CD), and 48 kHz (DAT).

Double Speed

Doubles the original sample rate range, in order to achieve higher audio quality and improved audio processing. 64 kHz is practically never used, 88.2 kHz is quite rare in spite of certain advantages. 96 kHz is a common format. Sometimes called **Double Fast**.

Quad Speed

Doubles the double sample rate for ensuring hi-end audio quality and processing. 128 kHz is non-existent, 176.4 kHz is rare, if at all then 192 kHz is used, e.g. for DVD Audio.

Single Wire

Standard audio data transfer, where the audio signal's sample rate is equal to the rate of the digital signal. Used from 32 to 192 kHz. Sometimes called **Single Wide**.

Double Wire

Before 1998 there were no receiver/transmitter circuits available that could receive or transmit more than 48 kHz. Higher sample rates were transferred by splitting odd and even bits across the L/R channels of a single AES connection. This provides for twice the data rate, and hence twice the sample rate. A stereo signal subsequently requires two AES/EBU ports.

The Double Wire method is an industry standard today with different names, like **Dual AES**, **Double Wide**, **Dual Line** and **Wide Wire**. The AES3 specification uses the uncommon term *Single channel double sampling frequency mode*. When used with the ADAT format, the term S/MUX is commonly used.

Double Wire not only works with Single Speed signals, but also with Double Speed. As an example, Pro Tools HD, whose AES receiver/transmitter only worked up to 96 kHz, used Double Wire to transmit 192 kHz. Four channels of 96 kHz turn into two channels of 192 kHz.

Quad Wire

Similar to Double Wire, with samples of one channel spread across four channels. This way single speed devices can transmit up to 192 kHz, but need two AES/EBU ports to transmit one channel. Also called **Quad AES**.

S/MUX

Since the ADAT hardware interface is limited to Single Speed, the Double Wire method is used for sample rates up to 96 kHz, but usually referred to as S/MUX (Sample Multiplexing). An ADAT port supports four channels this way. With MADI S/MUX is used as well, to transmit up to 96kHz although the 48K Frame format is used.

S/MUX4

The Quad Wire method allows to transmit two channels at up to 192 kHz via ADAT. The method is referred to as S/MUX4. With MADI S/MUX4 is used as well, to transmit up to 192 kHz although the 48K Frame format is used.

Note: All conversions of the described methods are lossless. The existing samples are just spread or re-united between the channels.

48K Frame

Most often used MADI format. Supports up to 64 channels at up to 48 kHz.

96K Frame

Frame format for up to 32 channels at up to 96 kHz. The advantage of this format against 48K Frame using S/MUX: the receiver can detect the real (double) sample rate on its own and immediately. With 48K Frame and S/MUX, the user has to set up the correct sample rate in all involved devices manually.