

User's Guide



Hammerfall[®] DSP System

Digiface

DVD

24 Bit / 96 kHz ✓

ready

TotalMix[™]



SyncAlign[®]

ZLM[®]

SyncCheck[®]



PCI Busmaster Digital I/O System
PCI and CardBus Interface
2 + 24 Channels SPDIF / ADAT Interface
24 Bit / 96 kHz Analog Stereo Monitor
ADAT Sync In
MIDI I/O

▶ **General**

1	Introduction	6
2	Package Contents	6
3	System Requirements	6
4	Brief Description and Characteristics	7
5	Hardware Installation	
5.1	PCI Interface.....	7
5.2	CardBus Card.....	7
5.3	Notes on Power Supply	8
6	First Usage – Quick Start	
6.1	Connectors and Front Panel	8
6.2	Quick Start.....	9
6.3	Notes on Laptops and CardBus	9
7	Accessories	10
8	Warranty	11
9	Appendix	11

▶ **Driver Installation and Operation - Windows**

10	Driver and Firmware	
10.1	Driver Installation	14
10.2	Driver Update.....	14
10.3	Deinstalling the Drivers	14
10.4	Firmware Update.....	15
11	Configuring the Digiface	
11.1	Settings Dialog.....	16
11.2	Clock Modes – Synchronization.....	18
12	Operation and Usage	
12.1	Playback	21
12.2	DVD Playback (AC-3 / DTS) under MME	22
12.3	Low Latency under MME	23
12.4	Multi-client Operation	23
12.5	Digital Recording	24
13	Operation under ASIO 2.0	
13.1	General	25
13.2	Known Problems	25
13.3	Synchronization – ADAT Sync.....	26
14	Operation under GSIF	27
15	Using more than one Hammerfall DSP	27
16	DIGICheck	28
17	Hotline – Troubleshooting	
17.1	General	28
17.2	Installation.....	29
18	Diagrams	
18.1	Channel Routing ASIO 96 kHz	30
18.2	Channel Routing MME 96 kHz.....	31

▶ **Driver Installation and Operation - Mac OS X**

19	Driver and Flash Update	
19.1	Driver Installation	33
19.2	Driver Update	33
19.3	Flash Update	33
20	Configuring the Digiface	
20.1	Settings Dialog	34
20.2	Clock Modes – Synchronization.....	36
21	Mac OS X FAQ	
21.1	Round about Driver Installation	38
21.2	MIDI doesn't work.....	38
21.3	Supported Sample Rates.....	39
21.4	Repairing Disk Permissions.....	39
21.5	PCI Compatibility	39
21.6	Various Information	39
22	Hotline – Troubleshooting	40
23	Diagram: Channel Routing at 96 kHz	41

▶ **Disconnect Mode, Connections and TotalMix**

24	Disconnect Mode	44
25	Analog Output Headphones	44
26	Digital Connections	
26.1	ADAT	45
26.2	SPDIF	45
26.3	Word Clock.....	46
26.4	MIDI	46
27	Word Clock	
27.1	Technical Description and Background.....	47
27.2	Cables and Termination	47
27.3	General Operation	48
28	TotalMix: Routing and Monitoring	
28.1	Overview.....	49
28.2	The User Interface.....	51
28.3	Elements of a Channel	52
28.4	Tour de TotalMix	52
28.5	Submix View	54
28.6	Mute and Solo	54
28.7	Quick Access Panel.....	55
28.8	Presets	55
28.9	Monitor Panel	57
28.10	Preferences	57
28.11	Editing the Names	58
28.12	Hotkeys	59
28.13	Menu Options	60
28.14	Level Meter	61

29	TotalMix: The Matrix	
29.1	Overview.....	62
29.2	Elements of the Matrix View.....	62
29.3	Operation.....	62
29.4	Advantages of the Matrix.....	63
30	TotalMix Super-Features	
30.1	ASIO Direct Monitoring (Windows only).....	63
30.2	Selection and Group based Operation.....	64
30.3	Copy Routings to other Channels.....	64
30.4	Delete Routings.....	64
30.5	Recording a Subgroup (Loopback).....	65
30.6	Using external Effects Devices.....	66
31	TotalMix MIDI Remote Control	
31.1	Overview.....	67
31.2	Setup.....	67
31.3	Operation.....	67
31.4	Mapping.....	68
31.5	Simple MIDI Control.....	69
31.6	Loopback Detection.....	69

► **Technical Reference**

32	Tech Info.....	71
33	Technical Specifications	
33.1	Analog.....	72
33.2	Digital.....	72
33.3	Digital Inputs.....	72
33.4	Digital Outputs.....	73
33.5	MIDI.....	73
33.6	Transfer Modes: Resolution/Bits per Sample.....	73
33.7	General.....	73
34	Technical Background	
34.1	Lock and SyncCheck.....	74
34.2	Latency and Monitoring.....	75
34.3	DS – Double Speed.....	76
34.4	AES/EBU – SPDIF.....	77
35	Block Diagram Digiface.....	78

User's Guide



Digiface

▶ General

1. Introduction

Thank you for choosing the RME Hammerfall DSP system. This unique audio system is capable of transferring analog and digital audio data directly to a computer from practically any device. The latest Plug and Play technology guarantees a simple installation, even for the inexperienced user. The numerous unique features and well thought-out configuration dialog puts the Hammerfall DSP at the very top of the range of computer-based audio interfaces.

The package contains drivers for Windows 2000 SP4, Windows XP, and Mac OS X.

Our high-performance philosophy guarantees maximum system performance by executing as many functions as possible not in the driver (i.e. the CPU), but directly within the audio hardware.

2. Package Contents

Please check your Hammerfall DSP component's package to include each of the following:

PCI Interface

- PCI card HDSP
- Quick Info guide
- RME Driver CD
- Cable IEEE1394, 4.5 m (15 ft)

CardBus Interface

- CardBus card
- Quick Info guide
- RME Driver CD
- Cable IEEE1394, 4.5 m (15 ft)
- 12 V car cable
- Battery cable
- Power supply 12 V / 1.25 A and power cord

Digiface

- I/O-box Digiface
- Quick Info guide
- RME Driver CD
- 1 optical cable (TOSLINK), 2 m (6.6 ft)

3. System Requirements

- Windows 2000 SP4, Windows XP, Mac OS X (10.28 or higher)
- PCI Interface: a free PCI rev. 2.1 Busmaster slot
- CardBus Interface: a free PCMCIA Slot type II, CardBus-compatible

Note: Examples and detailed descriptions of suitable audio desktop systems can be found in the Tech Info *RME Reference PCs: Hardware recommendations*. Information on compatibility and performance of notebooks/laptops is included in RMEs Tech Infos about notebooks, *HDSP System – Notebook Basics and Tests*.

4. Brief Description and Characteristics

- Hammerfall design: 0% (zero!) CPU load, even using all 52 ASIO channels
- All settings can be changed in real-time
- Analog, ADAT and SPDIF I/Os can be used simultaneously
- 8 buffer sizes/latencies available: 1.5 / 3 / 6 / 12 / 23 / 46 / 93 / 186 ms
- 12 channels 96 kHz/24 bit record/playback via ADAT optical (S/MUX)
- Clock modes slave and master
- Automatic and intelligent master/slave clock control
- Unsurpassed Bitclock PLL (audio synchronization) in ADAT mode
- Word clock input and output
- ADAT Sync In (9-pin D-sub) for sample-accurate transfers
- Zero Latency Monitoring for latency-free submixes and perfect ASIO Direct Monitoring
- SyncAlign guarantees sample aligned and never swapping channels
- SyncCheck tests and reports the synchronization status of input signals
- 2 x MIDI I/O, 16 channels high-speed MIDI
- 1 x Analog/Line headphone output, separate output for independent submix
- DIGICheck DSP: Level meter in hardware, peak- and RMS calculation
- TotalMix: 1456 channel mixer with 40 bit internal resolution

5. Hardware Installation

5.1 PCI Interface



Before installing the PCI card, please make sure the computer is switched off and the power cable is disconnected from the mains supply. Inserting or removing a PCI card while the computer is in operation can cause irreparable damage to both motherboard and card!

1. Disconnect the power cord and all other cables from the computer.
2. Remove the computer's housing. Further information on how to do this can be obtained from your computer's instruction manual.
3. Important: Before removing the card from its protective bag, discharge any static in your body by touching the metal chassis of the PC.
4. Insert the PCI card firmly into a free PCI slot, press and fasten the screw.
5. Replace the computer's housing.
6. Reconnect all cables including the power cord.
7. Connect PCI interface and Digiface using the supplied cable (IEEE1394). This is a standard FireWire cable (6-pin).

5.2 CardBus Card

Before inserting the CardBus card make sure the complete HDSP system is ready for operation!

1. Connect the CardBus card with the Digiface using the supplied cable.
2. Insert the CardBus card with the Hammer logo up into a PCMCIA slot.
3. Plug the power jack of the supplied switching power supply into the connector labeled AUX, on the rear of the Digiface.
4. Connect power cord to power supply, plug into AC outlet. The green LED of the power supply and the red LED of the Digiface will light up.
5. Switch on the notebook and boot the operating system.

5.3 Notes on Power Supply

- The **CardBus** card delivers **no** power to the Digiface. Therefore a hi-tech switching power supply is included.
- The **PCI** card operates as power supply for the attached Digiface via the FireWire cable. An external power supply is **not** required.

The Digiface draws a high startup current of more than 2.5 A during initialisation. Current at 12 Volt operating voltage: unloaded 200 mA (2.5 Watts), loaded 400 mA (4.8 Watts). Supply voltage range DC 8 V – 28 V, AC 8 V – 20 V.

6. First Usage – Quick Start

6.1 Connectors and Front Panel

The front of the Digiface features a MIDI input and output, a stereo headphone output and several status LEDs.

MIDI I/O 2 represent the second MIDI input and output, realized as 5-pin DIN jacks.

The LEDs **MIDI IN** and **OUT** indicate sent or received data for the MIDI ports.

The **INPUT STATE** LEDs (WC, SPDIF, ADAT) indicate a valid input signal separately for each digital input. Additionally, RME's exclusive *SyncCheck* indicates if one of these inputs is locked, but not synchronous to the others, in which case the LED will flash. See also chapter 11.2 / 20.2, Clock Modes - Synchronization.

The red **HOST** LED lights up when the power supply or the computer is switched on, thus signalling the presence of operating voltage. At the same time it operates as Error LED, in case the I/O-box wasn't initialised, or the connection to the interface has been interrupted (Error, cable not connected etc.). It flashes then. After the firmware had been loaded the LED turns off, signalling a proper operation.

The rear panel of the Digiface has the MIDI I/O 1, three ADAT optical I/Os, the power socket **AUX** (only necessary with CardBus operation), ADAT Sync input, Word Clock I/O, and the coaxial SPDIF input and output.

ADAT I/O 1-3 (TOSLINK): ADAT1 can also be used as optical SPDIF input and output, if set up accordingly in the Settings dialog. The Settings dialog is started by clicking on the hammer symbol in the Task Bar's system tray.

SPDIF I/O coaxial (RCA): Fully AES/EBU compatible by transformer-coupling and level adjustment. The Digiface accepts the commonly used digital audio formats, SPDIF as well as AES/EBU.

Word Clock I/O (BNC). The word clock input is not terminated.

ADAT Sync In for connection to ADAT Sync of an ADAT recorder. Allows for sample-accurate synchronization with ASIO 2.0.

6.2 Quick Start

After the driver installation (see chapter 10 / 19) connect the digital inputs and outputs to your other digital equipment.

The Digiface's digital outputs provide SPDIF (AES/EBU compatible) and ADAT optical signals at the corresponding ports.

An analog stereo output is available on the front. This output is a very low impedance type, which can also be used to connect headphones.

6.3 Notes on Laptops and CardBus

The HDSP system uses the notebook's PCMCIA type II port as *CardBus* interface. Compared to a PC-Card, which only has access to the outdated ISA-bus, CardBus is a 32 bit PCI interface. Like with a desktop system it's not possible to remove a PCI device while in operation. First the operating system has to receive a 'removal request', then the device has to be stopped. Finally the card can be pulled out of the PCMCIA slot.

Windows

When inserting the CardBus card it usually will be detected automatically by the notebook hardware and then the operating system. A beep signals the detection. In rare cases detection will fail. If so, simply remove the card and insert it again.

To remove the hardware click on the green arrow symbol in the systray. It is possible to stop the HDSP directly, or to first call up the info dialog by double clicking the symbol, and then stopping it.



Mac OS X

When inserting the CardBus card it usually is detected automatically by the notebook hardware and then by the Mac OS. A CardBus icon will appear on the top menu. A mouse click on the icon opens a drop-down menu, showing the card's name (Hammerfall DSP) and an option to switch it off.

To remove the CardBus card click on the menu entry 'Power off card'. The Mac OS internally de-installs the CardBus card and switches off power (the red Host LED begins to blink). The card can now be pulled out of the PCMCIA slot.

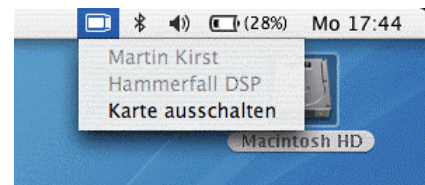

Tech Infos

The Hammerfall DSP System was tested thoroughly on several notebooks by RME. Basically the CardBus card operates with any tested device. Our website hosts several interesting Tech Infos with background information:

HDSP-System: Notebook Tests – Compatibility and Performance

HDSP System: Notebook Basics - Notebook Hardware

HDSP System: Notebook Basics - Background Knowledge and Tuning

The mobile operation of the HDSP system can cause problems. Explanations and solutions on digital noise, ground loops, headphone operation and Line Out wiring, power supplies and the mobile operation with battery can be found in the Tech Info:

HDSP System: Notebook Basics - The Audio Notebook in Practise.

7. Accessories

RME offers several optional accessories. Also parts of the HDSP system are available separately.

Part Number	Description
36000	19", 1UH Universal rack holder

This 19" rack holder has holes for Digiface and Digiface. Two units can be installed side by side in any combination. The rack holder also includes holes for nearly all 19" half-rack units from other manufacturers.

36001	Firewire cable IEEE1394 6M/6M, 1 m (3.3 ft)
36002	Firewire cable IEEE1394 6M/6M, 3 m (9.9 ft)
36005	Firewire cable IEEE1394 6M/6M, 5 m (16.4 ft)
36010	Firewire cable IEEE1394 6M/6M, 10 m (32.8 ft)

FireWire cable for the HDSP system, both sides 6-pin male. Cable longer than 16 ft is not allowed for FireWire, therefore hard to get in computer shops. However the HDSP system does not use FireWire protocol, therefore can operate flawlessly even with a cable length of up to 50ft (15 m).

36003	Optical cable, TOSLINK, 0.5 m (1.6 ft)
36004	Optical cable, TOSLINK, 1 m (3.3 ft)
36006	Optical cable, TOSLINK, 2 m (6.6 ft)
36007	Optical cable, TOSLINK, 3 m (9.9 ft)
36008	Optical cable, TOSLINK, 5 m (16.4 ft)
36009	Optical cable, TOSLINK, 10 m (33 ft)

Standard lightpipe with TOSLINK connectors, RME approved quality.

37011	Power supply for HDSP CardBus card
-------	------------------------------------

Robust and light weight switching power supply, 100V-240V AC, 12V 1.25 A DC.

8. Warranty

Each individual Hammerfall DSP undergoes comprehensive quality control and a complete test at RME before shipping. The usage of high grade components allow us to offer a full two year warranty. We accept a copy of the sales receipt as valid warranty legitimation.

If you suspect that your product is faulty, please contact your local retailer. The warranty does not cover damage caused by improper installation or maltreatment - replacement or repair in such cases can only be carried out at the owner's expense.

RME does not accept claims for damages of any kind, especially consequential damage. Liability is limited to the value of the Hammerfall DSP. The general terms of business drawn up by Synthax Audio AG apply at all times.

9. Appendix

RME news, driver updates and further product information are available on our website:

<http://www.rme-audio.com>

If you prefer to read the information off-line, you can browse through a complete copy of the RME website, found on the RME Driver CD (in the **rmeaudio.web** directory).

Manufacturer:

IMM Elektronik GmbH, Leipziger Strasse 32, D-09648 Mittweida

Trademarks

All trademarks, registered or otherwise, are the property of their respective owners. RME, DIGI96, SyncAlign, ZLM, SyncCheck, DIGICheck and Hammerfall are registered trademarks of RME Intelligent Audio Solutions. Digiface, TMS and TotalMix are trademarks of RME Intelligent Audio Solutions. Alesis and ADAT are registered trademarks of Alesis Corp. ADAT optical is a trademark of Alesis Corp. Microsoft, Windows 2000 and Windows XP are registered trademarks or trademarks of Microsoft Corp. Steinberg, Cubase and VST are registered trademarks of Steinberg Media Technologies GmbH. ASIO is a trademark of Steinberg Media Technologies GmbH.

Copyright © Matthias Carstens, 8/2005. Version 1.8
Current driver version: W2k/XP: 2.94, Mac OS X: 1.6

Although the contents of this User's Guide have been thoroughly checked for errors, RME can not guarantee that it is correct throughout. RME does not accept responsibility for any misleading or incorrect information within this guide. Lending or copying any part of the guide or the RME Driver CD, or any commercial exploitation of these media without express written permission from RME Intelligent Audio Solutions is prohibited. RME reserves the right to change specifications at any time without notice.

CE / FCC Compliance Statements

CE

This device has been tested and found to comply with the EN55022 class B and EN50082-1 norms for digital devices, according to the European Council directive on counterpart laws in the member states relating to electromagnetic compatibility (EMVG).

FCC

This device has been tested and found to comply with the requirements listed in FCC Regulations, part 15 for Class 'B' digital devices. Compliance with these requirements provides a reasonable level of assurance that your use of this product in a residential environment will not result in harmful interference with other electronic devices.

This equipment generates radio frequencies and, if not installed and used according to the instructions in the User's Guide may cause interference harmful to the operation of other electronic devices.

Compliance with FCC regulations does not guarantee that interference will not occur in all installations. If this product is found to be the source of interference, which can be determined by turning the unit off and on again, please try to eliminate the problem by using one of the following measures:

- Relocate either this product or the device that is being affected by the interference
- Use power outlets on different branch circuits, or install AC line filters
- Contact your local retailer or any qualified radio and television engineer

FCC compliance statement: Tested to comply with FCC standards for home or office use.

User's Guide



Digiface

- ▶ **Driver Installation and Operation - Windows**

10. Driver and Firmware

10.1 Driver Installation

After the interface has been installed correctly, connected to the Digiface (see 5. Hardware Installation), and the computer has been switched on, Windows will recognize the new hardware component and start its 'Hardware Wizard'. Insert the RME Driver CD into your CD-ROM drive, and follow further instructions which appear on your computer screen. The driver files are located in the directory `\HDSP_w2k` on the RME Driver CD.

Windows will install the Hammerfall DSP System driver, and will register the card in the system as a new audio device. After a reboot the Digiface is ready for use.

In case the warning messages 'Digital signature not found', 'Do not install driver', 'not certified driver' or similar come up: Don't listen to Microsoft, listen to us and continue with the installation.



In case the Hardware Wizard does not show up automatically after installation of the card, do not attempt to install the drivers manually! An installation of drivers for non-recognized hardware will cause a blue screen when booting Windows!

10.2 Driver Update

RME's driver updates often include a new `hdsp32.inf` file. Also the revision number of the hardware might change (after a flash update). To prevent Windows 2000/XP from using an old `hdsp32.inf`, or to copy some of the old driver files, be sure NOT to let Windows search for the driver! Instead tell Windows what to do.

Under `>Control Panel /System /Device Manager /Sound, Video and Game Controllers /RME Hammerfall DSP /Properties /Driver<` you'll find the 'Update Driver' button. Select **'Install from a list or specific location (advanced)'**, click **'Next'**, select **'Don't search I will choose the driver to install'**, click **'Next'**, then **'Have Disk'**. Now point to the driver update's directory.

10.3 Deinstalling the Drivers

A deinstallation of the HDSP's driver files is not necessary – and not supported by Windows anyway. Thanks to full Plug & Play support, the driver files will not be loaded after the hardware has been removed. If desired these files can then be deleted manually.

Unfortunately Windows Plug & Play methods do not cover the additional autorun entries of TotalMix, the Settings dialog, and the registration of the ASIO driver. Those entries can be removed from the registry through a software deinstallation request. This request can be found (like all deinstallation entries) in *Control Panel, Software*. Click on the entry 'RME Hammerfall DSP'.

10.4 Firmware Update

The Flash Update Tool updates HDSP PCI cards or CardBus cards to the latest version. It requires an already installed driver.

Start the program **hdsp_fut.exe**. The Flash Update Tool displays the current revision of the HDSP interface, and whether it needs an update or not. If so, then please manually select if a PCI card (desktop computer) or a CardBus card (laptop) shall be flashed. Next simply press the 'Update' button. A progress bar will indicate when the flash process is finished. The bar moves slowly first (program), then faster (verify).

If more than one interface card is installed, all cards can be flashed by changing to the next tab and repeating the process.

After the update the PCI/CardBus cards need to be resetted. This is done by powering down and shutting off the PC. A warm boot is not enough!

PCI card revision 1.8 or up (black PCB), CardBus with 6-pin FireWire connector

When the update fails (status: failure), the card's second BIOS will be used from the next cold boot on (Secure BIOS Technology). Therefore the card stays fully functional. The flash process should then be tried again on a different computer.

All other PCI cards, and CardBus with 15-pin flat connector

When the update fails (status: failure) the flash process should be repeated several times, until no error message occurs anymore. If the failure message is displayed nonetheless, the interface will most probably no longer work when the computer is switched off and on again. The interface then has to be re-programmed at the factory. We have invested a lot of work to prevent the system from getting in this state. If it happens despite our efforts, the best advice we can give is to not switch off the computer! As long as it is not switched off the old programming of the PCI/CardBus interface will stay active, and you can continue to work with the system using the old drivers

Note: Because of the changed hardware revision, Windows 2000/XP will start the hardware assistant and wants to install new drivers. Do NOT let Windows search for new drivers, but follow the instructions given in chapter 10.2.

11. Configuring the Digiface

11.1 Settings Dialog

Configuration of the HDSP system Digiface is done via its own settings dialog. The panel 'Settings' can be opened:

- by clicking on the hammer symbol in the Task Bar's system tray

The mixer of the Hammerfall DSP system (TotalMix) can be opened:



- by clicking on the mixer icon in the Task Bar's system tray

The hardware of the HDSP system offers a number of helpful, well thought-of practical functions and options which affect how the card operates - it can be configured to suit many different requirements. The following is available in the 'Settings' dialog:

- Input selection
- Configuration of digital I/Os
- Output status
- Synchronization behaviour
- State of input and output

Any changes made in the Settings dialog are applied immediately - confirmation (e.g. by clicking on OK or exiting the dialog) is not required. However, settings should not be changed during playback or record if it can be avoided, as this can cause unwanted noises. Also, please note that even in 'Stop' mode, several programs keep the recording and playback devices open, which means that any new settings might not be applied immediately.

The status displays at the bottom of the dialog box give the user precise information about the current status of the system, and the status of all digital signals.

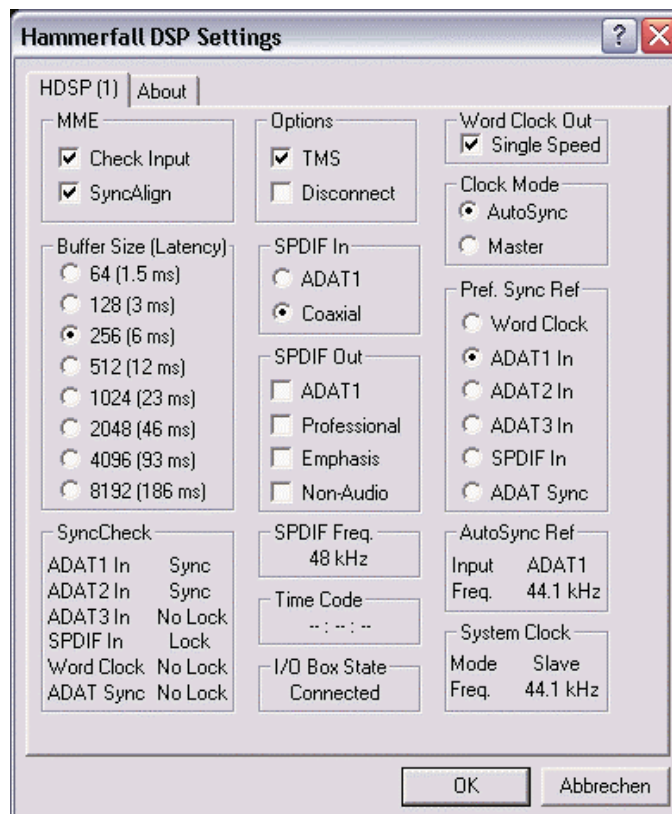

SyncCheck indicates whether there is a valid signal (Lock, No Lock) for each input (Word Clock, ADAT1-3, SPDIF, ADAT Sync), or if there is a valid *and* synchronous signal (Sync). The *AutoSync Ref(ference)* display shows the input and frequency of the current sync source.

MME

Check Input verifies the current digital input signal against the settings in the record program. When de-activated a recording will always be allowed, even with non-valid input signals. *Check Input* is valid for MME only.

SyncAlign guarantees synchronous channels when using MME multitrack software. This option should only be switched off in case the used software does not work correctly with *SyncAlign* activated.

Buffer Size

The setting *Buffer Size* determines the latency between incoming and outgoing ASIO and GSIF data, as well as affecting system stability (see chapter 13/14). Under Windows MME this setting determines the DMA buffer size (see chapter 12.3).

SyncCheck

SyncCheck indicates whether there is a valid signal (Lock, No Lock) for each input (Word Clock, ADAT, SPDIF, ADAT Sync), or if there is a valid *and* synchronous signal (Sync). The *AutoSync Reference* display shows the input and frequency of the current sync source.

Options

TMS activates the transmission of Channel Status data and Track Marker information of the SPDIF input.

Disconnect interrupts the communication between I/O-box and PCI or CardBus card. In case the Digiface has been configured using the Settings dialog and TotalMix, *Disconnect* allows to use it Stand-Alone (without a connected computer), after a power supply has been attached.

SPDIF In

Defines the input for the SPDIF signal. 'Coaxial' relates to the RCA socket, 'Optical' to the optical TOSLINK input ADAT1.

SPDIF Out

The SPDIF output signal is constantly available at the phono plug. After selecting 'ADAT1' it is also routed to the optical TOSLINK output ADAT1. For further details about the settings 'Professional', 'Emphasis' and 'Non-Audio', please refer to chapter 26.2.

SPDIF Freq.

Displays the sample rate of the signal at the SPDIF input.

Time Code

Time Code from the input ADAT Sync.

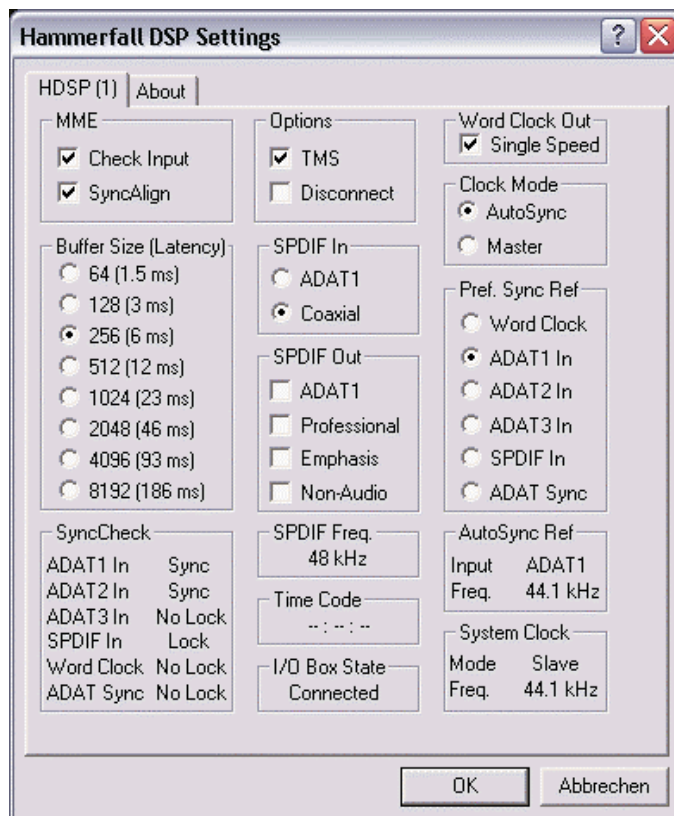

I/O Box State

This field displays the current state of the I/O-box.

<i>Error:</i>	I/O-box not connected or missing power
<i>Detected:</i>	The interface has found an I/O-box and tries to load the firmware
<i>Connected:</i>	Communication between interface and I/O-box operates correctly
<i>Disconnected:</i>	Communication between interface and I/O-box has been interrupted, I/O-box continues operation

Word Clock Out

The word clock output signal usually equals the current sample rate. Selecting *Single Speed* causes the output signal to always stay within the range of 32 kHz to 48 kHz. So at 96 kHz sample rate, the output word clock is 48 kHz.

Clock Mode

The unit can be configured to use its internal clock source (Master), or the clock source pre-defined via *Pref. Sync Ref* (AutoSync).

Pref. Sync Ref.

Used to pre-select the desired clock source. If the selected source isn't available, the unit will change to the next available one. The current clock source and sample rate is displayed in the *AutoSync Ref* display.

The automatic clock selection checks and changes between the clock sources Word Clock, ADAT, ADAT Sync and SPDIF.

System Clock

Shows the current clock state of the HDSP system. The system is either Master (using its own clock) or Slave (see AutoSync Ref).

11.2 Clock Modes - Synchronisation

In the digital world, all devices are either the 'Master' (clock source) or a 'Slave' synchronized to the master. Whenever several devices are linked within a system, there must always be a single master clock. The Hammerfall DSP's intelligent clock control is very user-friendly, being able to switch between clock modes automatically. Selecting **AutoSync** will activate this mode.

In AutoSync mode, the system constantly scans all digital inputs for a valid signal. If this signal corresponds with the current playback sample rate, the card switches from the internal quartz (AutoSync Ref displays 'Master') to a clock generated from the input signal (AutoSync Ref displays 'Slave'). This allows on-the-fly recording, even during playback, without having to synchronize the card to the input signal first. It also allows immediate playback at any sample rate without having to reconfigure the card.

AutoSync guarantees that normal record and record-while-play will always work correctly. In certain cases however, e.g. when the inputs and outputs of a DAT machine are connected directly to the Hammerfall DSP, AutoSync may cause feedback in the digital carrier, so synchronization breaks down. To remedy this, switch the HDSP's clock mode over to 'Master'.



Remember that a digital system can only have one master! If the HDSP's clock mode is set to 'Master', all other devices must be set to 'Slave'.

The Hammerfall DSP's ADAT optical input and the SPDIF input operate simultaneously. Because there is no input selector however, the HDSP has to be told which of the signals is the sync reference (a digital device can only be clocked from a *single* source). This is why the system has been equipped with automatic clock source selection, which adopts the first available input with a valid digital signal as the clock reference input. The input currently used as sync reference is shown in the *AutoSync Ref* status field, together with its sample frequency.

Via *Pref. Sync Ref* (preferred synchronization reference) a preferred input can be defined. As long as the card sees a valid signal there, this input will be designated as the sync source, otherwise the other inputs will be scanned in turn. If none of the inputs are receiving a valid signal, the card automatically switches clock mode to 'Master'.

To cope with some situations which may arise in studio practice, setting 'Pref Sync Ref' is essential. One example: An ADAT recorder is connected to the ADAT1 input (ADAT1 immediately becomes the sync source) and a CD player is connected to the SPDIF input. Try recording a few samples from the CD and you will be disappointed. Few CD players can be synchronized. The samples will inevitably be corrupted, because the signal from the CD player is read with the (wrong) clock from the ADAT i.e. out of sync. In this case, 'Pref Sync Ref' should be temporarily set to SPDIF.

If several digital devices are to be used simultaneously in a system, they not only have to operate with the same sample frequency but also be synchronous with each other. This is why digital systems always need a single device defined as 'master', which sends the same clock signal to all the other ('slave') devices.

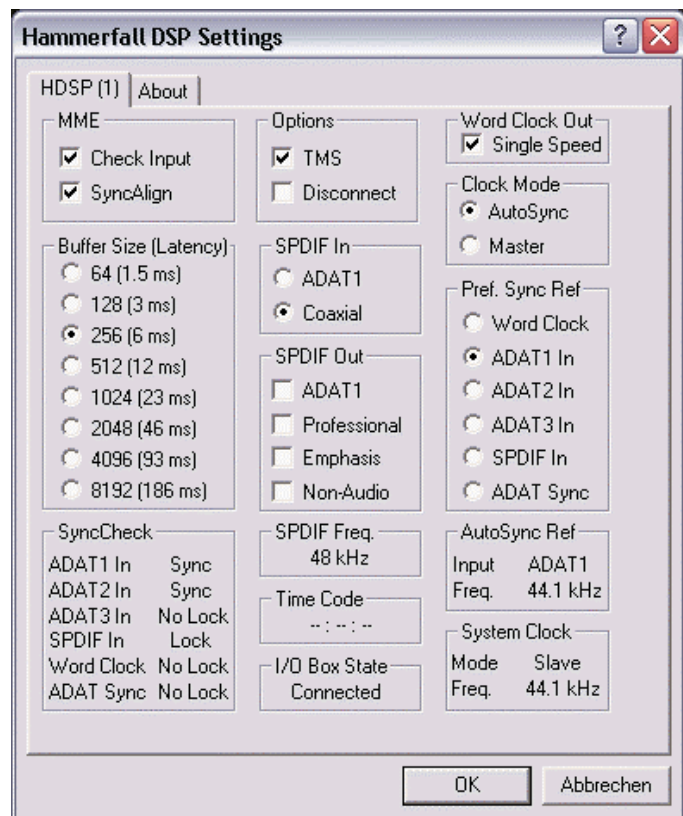

RME's exclusive **SyncCheck** technology (first implemented in the Hammerfall) enables an easy to use check and display of the current clock status. The 'SyncCheck' field indicates whether no signal ('No Lock'), a valid signal ('Lock') or a valid *and* synchronous signal ('Sync') is present at each of the digital clock source inputs. The 'AutoSync Ref' display shows the current sync source and the measured frequency.

In practice, SyncCheck provides the user with an easy way of checking whether all digital devices connected to the system are properly configured. With SyncCheck, finally anyone can master this common source of error, previously one of the most complex issues in the digital studio world.

An example to illustrate this: The ADAT1 and ADAT2 inputs are receiving signals from a digital mixing desk that has been set to clock mode 'Internal' or 'Master'. An ADAT recorder is connected to input ADAT3. The Hammerfall DSP is set to AutoSync mode. As expected, Sync-Check shows that the ADAT1 and ADAT2 inputs are in sync (as they are driven by the same clock from the mixing desk), but shows 'Lock' instead of 'Sync' for the input ADAT3. Because the ADAT recorder is not receiving any signal from HDSP or from the mixer, it will generate its own clock at a rate which is (almost) the same as the sample frequency of the mixing desk - but not identical.

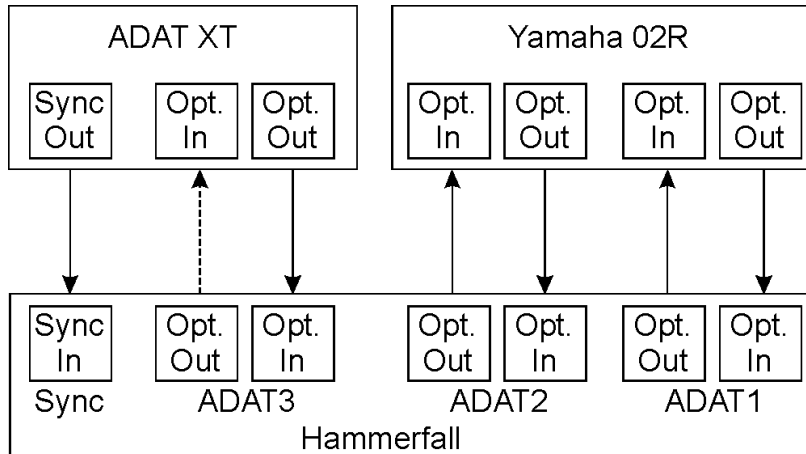

Remedy: To drive the ADAT recorder from its digital input, set it to slave mode (DIG), and connect the input to the HDSP's ADAT3 output. The Hammerfall DSP is already in sync with the mixing desk, so it will send an identical (synchronous) signal to ADAT3 out. The ADAT recorder will lock onto this, its output will also be in sync. The signal from the ADAT recorder is now fully in sync with the signals from the mixing desk.

Thanks to its AutoSync technique and lightning fast PLLs, the HDSP is not only capable of handling standard frequencies, but also any sample rate between 28 and 103 kHz. Even the word clock input, which most users will use in varispeed operation, allows any frequency between 28 kHz and 105 kHz.

At 88.2 or 96 kHz: If one of the ADAT inputs has been selected in 'Pref Sync Ref', the sample frequency shown in the field *SPDIF Freq.* differs from the one shown in 'AutoSync Ref'. The card automatically switches to S/MUX mode here, because ADAT optical inputs and outputs are only specified up to 48 kHz. Data from/to a single input/output is spread over two channels, the internal frequency stays at 44.1 or 48 kHz. In such cases, the ADAT sample frequency is only half the SPDIF frequency.

12. Operation and Usage

12.1 Playback

The HDSP system can play back audio data only in supported modes (channels, PCM) and formats (sample rate, bit resolution). Otherwise an error message appears (for example at 22 kHz and 8 bit).

In the audio application being used, HDSP must be selected as output device. This can often be found in the *Options*, *Preferences* or *Settings* menus under *Playback Device*, *Audio Devices*, *Audio* etc.

We strongly recommend switching off all system sounds (via >*Control Panel /Sounds*<). Also HDSP should not be the *Preferred Device* for playback, as this could cause loss of synchronization and unwanted noises. If you feel you cannot do without system sounds, you should consider buying a cheap Blaster clone and select this as *Preferred Device* in >*Control Panel /Multimedia /Audio*<.

The screenshot shows a typical configuration dialog of a (stereo) wave editor. After selecting a device, audio data is sent to either an ADAT or SPDIF port, depending on which has been selected as playback device.

Increasing the number and/or size of audio buffers may prevent the audio signal from breaking up, but also increases latency i.e. output is delayed. For synchronized playback of audio and MIDI (or similar), be sure to activate the checkbox 'Get position from audio driver'.

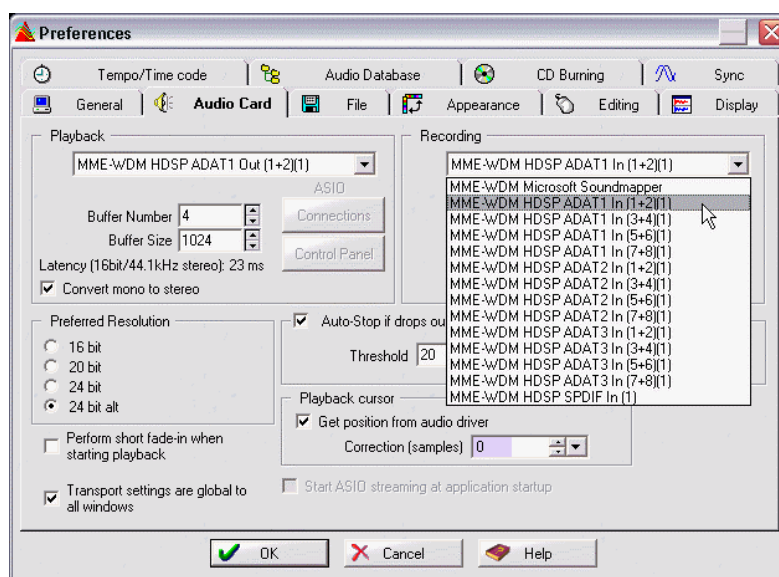

The HDSP system's ADAT optical interface allows sample rates of up to 96 kHz using a standard ADAT recorder. Single-channel data at this frequency requires two ADAT channels, achieved using the *Sample Multiplexing* technique. This reduces the number of available ADAT channels from 8 to 4 per ADAT port. Under Windows MME, channels are routed to ADAT devices in double-speed mode as follows:

- Only stereo pairs (1+2) and (3+4) of the ADAT port are available

This kind of implementation allows a problem-free usage of the ADAT port in both Single and Double Speed, as the routing doesn't change. However, the hardware spreads the data differently: Channel 1 is transmitted via channels 1 and 2, channel 2 via 3 and 4 etc.

Please refer to the diagram in chapter 18.2. Routing for record and playback is identical.

12.2 DVD-Playback (AC-3/DTS) under MME

AC-3 / DTS

When using popular DVD software player like WinDVD and PowerDVD, their audio data stream can be sent to any AC-3/DTS capable receiver, using the Hammerfall DSP's SPDIF output. For this to work the SPDIF output wave device has to be selected in *>Control Panel/ Sounds and Multimedia/ Audio<*. Also check 'use preferred device only'.

You will notice that the DVD software's audio properties now allow to use 'SPDIF Out', 'Use SPDIF' or to 'activate SPDIF output'. When selecting these, the software will transfer the non-decoded digital multichannel data stream to the Hammerfall DSP.

This 'SPDIF' signal sounds like chopped noise at highest level. Therefore the Digiface automatically activates the non-audio bit within the digital data stream, to prevent most SPDIF receivers from accepting the signal, and to prevent any attached equipment from being damaged.

Multichannel

PowerDVD can also operate as software decoder, sending a DVD's multichannel data stream directly to the ADAT outputs of the Digiface. Supported are all modes, from 2 to 8 channels, at 16 bit resolution and 48 kHz sample rate.

For this to work an output wave device of the HDSP has to be selected in *>Control Panel/ Sounds and Multimedia/ Audio<*. Also check 'use preferred device only'. PowerDVD's audio properties now lists several multichannel modes. If one of these is selected, PowerDVD sends the decoded (analog) multichannel data to the HDSP.

The device selected as *Preferred Playback Device* defines the first playback channel. Choosing ADAT 3/4 and 6-channel mode, playback will happen on channels 11 to 16. Choosing ADAT 21/22 and 6-channel mode, even the SPDIF output will be used for the last (highest) channels.



The available modes depend on the number of channels available above the chosen device! When selecting ADAT 23/24, the 6-channel mode will not be available.

The channel assignment using PowerDVD is:

- 1 (first chosen playback channel) - Left
- 2 - Right
- 3 - Center
- 4 - LFE (Low Frequency Effects)
- 5 - SR (Surround Right)
- 6 - SL (Surround Left)

Note 1: Setting the card to be used as system playback device is against common sense, as professional cards are not specialized to play back system sounds, and shouldn't be disturbed by system events. To prevent this, be sure to re-assign this setting after usage, or to disable any system sounds (tab Sounds, scheme 'No audio').

Note 2: The DVD player will be synced backwards from the HDSP card. This means when using AutoSync and/or word clock, the playback speed and pitch follows the incoming clock signal.

Note 3: PowerDVD 5 no longer supports a starting channel other than channel 1. Use TotalMix to send audio to the ADAT port if necessary.

Note 4: In WinDVD 5 and 6, a channel-separated 5.1 playback using the HDSP requires a change in the registry. Start regedit, go to *>HKEY_CURRENT_USER / Software / InterVideo / DVD5 / AUDIOCHAN<*, and set its value to 4 (hexadecimal). Additionally select 'Waveout' as Audio Renderer in the Audio configuration dialog. **Warning: Changes to the registry are done at your own risk. Danger of complete data loss!**

12.3 Low Latency under MME (Buffer Size Adjustment)

Using Windows 95 or 98 the MME buffer size was nothing to worry about. Latencies below 46 ms were not possible. Meanwhile both computers and operating system have become much more powerful, and since Windows ME/2000/XP latencies far lower can be used. SAWStudio and Sonar allowed to use such low settings from the start. Sequoia was updated in version 5.91, WaveLab in version 3.04.

In the HDSP's Settings dialog the MME buffersize (in fact the DMA buffer size) is set with the same buttons as the ASIO buffer size. Our test computers allow to use settings down to 64 samples without clicks. Please note that this setting only defines the buffer size of the hardware. The true and effective latency is configured within the MME application!



Attention: the DMA buffers must not be larger than the application's buffers. Playback will be stuttering and audio will be distorted.

This case can happen unnoticed when using ASIO and MME at the same time (multi-client) and setting ASIO to 186 ms, while the buffers in the MME application are still set for a lower latency.

Example: when you set the Hammerfall to 512 you can't use 128 in any program. But setting the buffer size to 128 allows to use 128 and all higher values within the software.

Please also note that this is a *you're-welcome-to-try* feature. We can't guarantee that you will be able to use 3 or 6 ms with MME. Simply check out by yourself which lowest setting your system and software allows. Some motherboards with insufficient PCI bandwidth (like older VIA boards) suffer from crackling at settings below 512. Be sure to set the buffer size to 512 or higher in such a case (or get a new motherboard).

12.4 Multi-client Operation

RME audio interfaces support multi-client operation. This means several programs can be used at the same time. Also all formats, like ASIO, MME and GSIF can be used simultaneously. The use of multi-client operation requires to follow two simple rules:

- *Multi-client operation requires identical sample rates!*

I.e. it is not possible to use one software with 44.1 kHz and the other with 48 kHz.

- *Different software can not use the same channels at the same time.*

If for example Cubase uses channels 1/2, this playback pair can't be used in Gigasampler/Studio (GSIF) nor under MME (WaveLab etc.) anymore. This is no limitation at all, because TotalMix allows any output routing, and with this a playback of multiple software on the same hardware outputs. Note that the inputs can be used at the same time, as the driver sends the data to all applications simultaneously.

ASIO-Multiclient

RME audio interfaces support ASIO multi-client operation. It is possible to use more than one ASIO software at the same time. Again the sample rate has to be identical, and each software has to use its own playback channels. Once again the same inputs can be used simultaneously.

RME's sophisticated tool *DIGICheck* is an exception to this rule. It operates like an ASIO host, using a special technique to access playback channels already occupied. Therefore DIGICheck is able to analyse and display playback data from any software, no matter which format the software uses.

12.5 Digital Recording

Unlike analog soundcards which produce empty wave files (or noise) when no input signal is present, digital I/O cards always need a valid input signal to start recording.

To take this into account, RME has included three unique features in the Hammerfall DSP system: a comprehensive I/O signal status display (showing sample frequency, lock and sync status) in the Settings dialog, status LEDs for each input, and the protective *Check Input* function.

If a 48 kHz signal is fed to the input and the application is set to 44.1 kHz, *Check Input* stops the system from recording. This prevents faulty takes, which often go unnoticed until later on in the production. Such tracks appear to have the wrong playback rate - the audio quality as such is not affected.

The sample frequency shown in the Settings dialog (see chapter 11, screenshot Settings) is useful as a quick display of the current configuration (the box itself and all connected external equipment). If no sample frequency is recognized, it will read 'No Lock'.

This way, configuring any suitable audio application for digital recording is simple. After selecting the required input, Hammerfall DSP displays the current sample frequency. This parameter can then be changed in the application's audio attributes (or similar) dialog.

The screenshot to the right shows a typical dialog used for changing basic parameters such as sample frequency and resolution in an audio application.

Any bit resolution can be selected, providing it is supported by both the audio hardware and the software. Even if the input signal is 24 bit, the application can still be set to record at 16-bit resolution. The lower 8 bits (and therefore any signals about 96dB below maximum level) are lost entirely. On the other hand, there is nothing to gain from recording a 16-bit signal at 24-bit resolution - this would only waste precious space on the hard disk.



It often makes sense to monitor the input signal or send it directly to the output. This can be done at zero latency using **TotalMix** (see chapter 28).

Currently two solutions exist which enable an *automated* control of real-time monitoring. ZLM (Zero Latency Monitoring) allows monitoring in Punch I/O mode - with this the system behaves like a tape machine. This method has been implemented in all versions of Samplitude (by Magix), and can be activated using the global track option 'Hardware monitoring during Punch'. As ZLM is limited to MME, this mode is no longer supported since TotalMix version 2.90.

The second solution is Steinberg's ASIO protocol with our ASIO 2.0 drivers and all ASIO 2.0 compatible programs (even Samplitude...). When 'ASIO Direct Monitoring' has been switched on, the input signal is routed in real-time to the output whenever a recording is started.

13. Operation under ASIO 2.0

13.1 General

Start the ASIO software and select **ASIO Hammerfall DSP** as the audio I/O device. The 'ASIO system control' button opens the HDSP's Settings dialog (see chapter 10 / 20, Configuration).

Hammerfall DSP supports *ASIO Direct Monitoring* (ADM). Please note that currently Nuendo, Cubase and Logic either do not support ADM completely or error-free.

Using emulated MIDI drivers often causes a drift and delay between audio and MIDI. You should use non-emulated (MME) MIDI ports in such a case.

At a sample rate of 88.2 or 96 kHz, the ADAT optical input and output operate in S/MUX mode, so the number of available channels is reduced from 8 to 4.

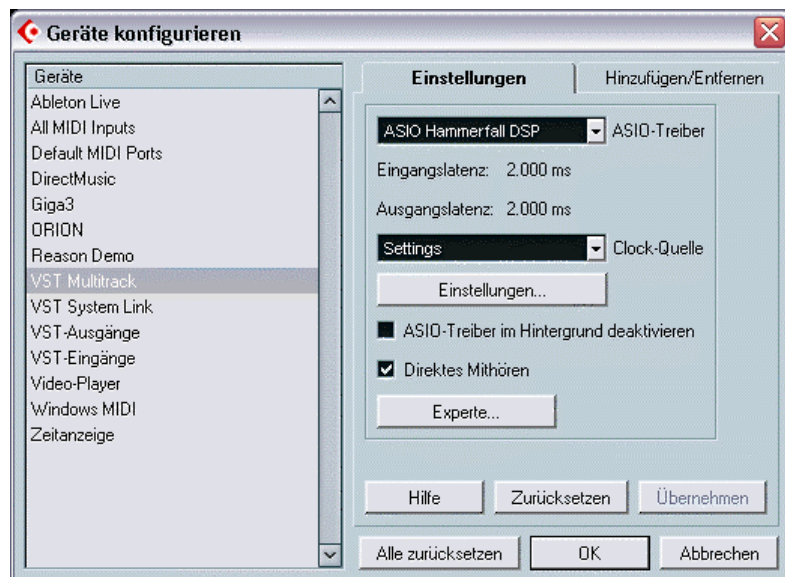

13.2 Known Problems

If a computer does not provide sufficient CPU-power and/or sufficient PCI-bus transfer rates, then drop outs, crackling and noise will appear. We recommend to deactivate all Plugins to verify that these are not the reason for such effects.

Additional hard disk controllers, both on-board and PCI based, often violate the PCI specs. To achieve the highest throughput they hog the PCI bus, even in their default setting. Thus when working with low latencies heavy drop outs (clicks) are heard. Try to solve this problem by changing the default setting of the controller (for example by reducing the 'PCI Bus Utilization').

Another common source of trouble is incorrect synchronization. ASIO does not support asynchronous operation, which means that the input and output signals not only have to use the same sample frequency, but also have to be in sync. All devices connected to the Hammerfall DSP must be properly configured for Full Duplex operation. As long as SyncCheck (in the Settings dialog) only displays *Lock* instead of *Sync*, the devices have not been set up properly!

When using more than one HDSP system, all units have to be in sync, see chapter 15. Else a periodically repeated noise will be heard.

13.3 Synchronization

To achieve sample-accuracy between the ADAT recorder and Hammerfall DSP while running Cubase, connect the ADAT sync output with the 9-pin D-type sync input of the HDSP. The 'Time Code' field in the Settings dialogue should now show the same position as the ADAT recorder.

Double-clicking on the Sync button in Cubase's transport panel will open the 'Synchronization' dialog. Select ASIO 2.0 as the timecode base (under Sync Source), confirm the dialog with 'OK', then activate Sync mode by (single) clicking on the Sync button.

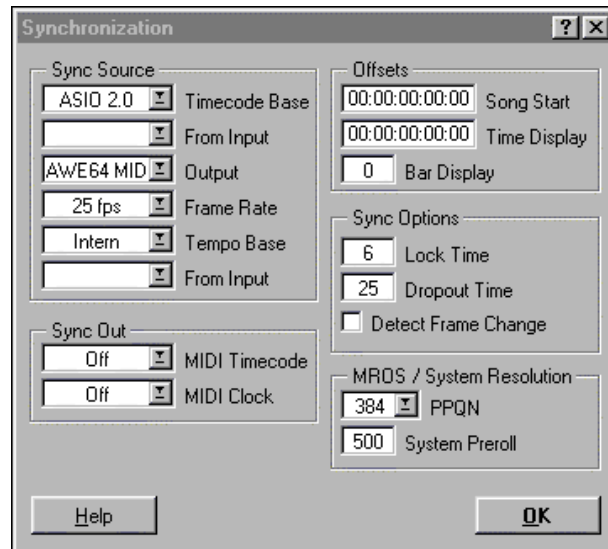

If synchronization is not working i.e. Cubase does not respond when the ADAT is set to 'Play', please try the following:

- Check the cables
- Switch Sync off and on again (in Cubase's transport panel)
- Select 'Reset Devices' from the Options menu.
- Switch on the ADAT recorder(s) before starting Cubase
- Use the BRC as Master and send its word clock to all other devices
- Use the Clock Mode *ADAT Sync*

14. Operation under GSIF (Gigasampler Interface)

Windows 2000/XP

The GSIF interface of the Hammerfall DSP allows direct operation with Gigastudio, with up to 26 channels, 96 kHz and 24 bit. The new GSIF 2.0 is also supported with both audio and MIDI.

Gigastudio requires a lot of the computer's calculation power. An optimum performance is achieved with a stand-alone GSIF PC. However, when using the Hammerfall DSP, the latency is always the same as the one selected for ASIO operation. This can cause performance problems on slower machines when using GSIF and ASIO at the same time.

Please note that the W2k/XP driver fully supports multi-client operation, including the combination MME/ASIO. So for example Cubase, Gigastudio and Sonar can be used simultaneously, provided each of these programs uses its own audio channels exclusively. For example ASIO could use channels 1/2 and Gigastudio (with GSIF) channels 3/4 simultaneously, and so on.



Simultaneous operation of GSIF and ASIO requires to use different channels. For example, if Cubase uses tracks 1/2 these tracks can not be used by Gigastudio.

Common Problems

Please note that Gigastudio is running unexpectedly in the background (thus blocking its assigned audio channels), as soon as the Gigastudio MIDI ports are used – even when Gigastudio itself hasn't been started. This causes a lot of confusion, as the driver seems to behave completely buggy, and the user does not recognize the simple reason for it – for example simultaneous operation of ASIO and GSIF on the same channels.

In case Gigastudio loads well, loads gig files too, but won't play at all even when using the virtual keyboard: Go to Hardware/Routing and select a valid MIDI input port. Note that blank is not valid, but <none> is.

15. Using more than one Hammerfall DSP

The current drivers support operation of up to three Hammerfall DSP systems. Different I/O-boxes may be used, in any combination. Digiface, Multiface II, Multiface, HDSP 9632 and HDSP 9652 use the same driver, therefore can be used at the same time. Please note that only one *ADAT Sync In* can be used (of course). All units have to be in sync, i.e. have to receive valid sync information either via word clock or by using AutoSync and feeding synchronized signals.

- If one of the HDSP systems is set to clock mode Master, all others have to be set to clock mode AutoSync, and have to be synced from the master, for example by feeding word clock. The clock modes of all units have to be set up correctly in their Settings dialog.
- If all units are fed with a synchronous clock, i.e. all units show *Sync* in their Settings dialog, all channels can be used at once. This is especially easy to handle under ASIO, as the ASIO driver presents all units as one.

Note: TotalMix is part of the hardware of each HDSP system. Up to three mixers are available, but these are separated and can't interchange data. Therefore a global mixer for all units is not possible.

16. DIGICheck

The DIGICheck software is a unique utility developed for testing, measuring and analysing digital audio streams. Although this Windows software is fairly self-explanatory, it still includes a comprehensive online help. DIGICheck 4.4 operates as multi-client ASIO host, therefore can be used in parallel to any software, be it MME, ASIO or GSIF, with both inputs and outputs (!). The following is a short summary of the currently available functions:

- **Level Meter.** High precision 24-bit resolution, 2/8/18 channels. Application examples: Peak level measurement, RMS level measurement, over-detection, phase correlation measurement, dynamic range and signal-to-noise ratios, RMS to peak difference (loudness), long term peak measurement, input check. Oversampling mode for levels higher than 0 dBFS. Vertical and horizontal mode. Slow RMS and RLB weighting filter. Supports visualization according to the K-system.
- **Hardware Level Meter for Input, Playback and Output.** As above, received pre-calculated directly from the HDSP system hardware with near zero CPU load.
- **Spectral Analyser.** World wide unique 10-, 20- or 30-band display in analog bandpass-filter technology. 192 kHz-capable!
- **Vector Audio Scope.** World wide unique Goniometer showing the typical afterglow of an oscilloscope-tube. Includes Correlation meter and level meter.
- **Totalyser.** Spectral Analyser, Level Meter and Vector Audio Scope in a single window.
- **Bit Statistics & Noise.** Shows the true resolution of audio signals as well as errors and DC offset. Includes Signal to Noise measurement in dB and dBA, plus DC measurement.
- **Channel Status Display.** Detailed analysis and display of SPDIF and AES/EBU Channel Status data.
- **Completely multi-client.** Open as many measurement windows as you like, on any channels and inputs or outputs!

To install DIGICheck, go to the **\DIGICheck** directory on the RME Driver CD and run *setup.exe*. Follow the instructions prompted on the screen.

DIGICheck is constantly improved. The latest version is always found on our website www.rme-audio.de, section **Downloads/Tools**.

17. Hotline – Troubleshooting

17.1 General

The newest information can always be found on our website www.rme-audio.com, section FAQ, Latest Additions.

The input signal cannot be monitored in real-time

- ASIO Direct Monitoring has not been enabled, and/or monitoring has been disabled globally (for example in TotalMix).

The 8 ADAT channels don't seem to work

- The optical output ADAT1 has been switched to 'SPDIF'. The ADAT playback devices are still usable by routing and mixing them in TotalMix to other outputs.

Low Latency ASIO operation under Windows 2000/XP on single CPU systems:

- To use ASIO at lowest latencies under Windows 2000/XP even when only having one CPU, the system performance has to be optimized for background tasks. Go to **>Control Panel/System/Advanced/Performance Options<**. Change the default 'Applications' to 'Background tasks'. The lowest usable latency will drop from 23 ms to around 3 ms.

Playback works, but record doesn't

- Check that there is a valid signal at the input. If so, the current sample frequency is displayed in the Settings dialog.
- Check whether the HDSP system has been selected as recording device in the audio application.
- Check whether the sample frequency set in the audio application ('Recording properties' or similar) matches the input signal.
- Check that cables/devices have not been connected in a closed loop. If so, set the systems's clock mode to Master.

Crackle during record or playback

- Increase the number and size of buffers in the 'Settings' dialog or in the application.
- Try different cables (coaxial or optical) to rule out any defects here.
- Check that cables/devices have not been connected in a closed loop. If so, set the system's clock mode to 'Master'.
- Increase the buffer size of the hard disk cache.
- Activate Busmaster mode for the hard disks.
- In case of a recently done BIOS update of the motherboard: Propably 'Load BIOS Defaults' was loaded instead of 'Load Setup Defaults'. This sets the 'PCI Latency Timer' to 0 (default: 32).

ADAT timecode is running, but Cubase does not start 'Play' automatically

- The input displayed in 'Sync Ref' is not in sync mode. Sync mode is essential, because ADAT's so-called time code is really a sample position, and is therefore only valid for synchronous audio data.
- Sync is displayed (referring to the card's clock), but the incoming data is not in sync with the sample position received at the ADAT Sync In. Then Cubase does not start. Remedy: Set 'Pref. Sync Ref' to the input corresponding to the received ADAT Sync signal.
- Sync mode wasn't activated (button in the transport panel), or ASIO 2.0 has not been chosen as the SMPTE sync source.

The ADAT timecode is not in sync

- The tape is formatted to 48 kHz, but played back at 44.1 kHz (Pitch). This 'Blackface' problem cannot be solved in a satisfactory way.

17.2 Installation

Hammerfall DSP is found in the Device Manager (>Settings/ Control Panel/ System<), category 'Sound-, Video- and Gamecontroller'. A double click on ' Hammerfall DSP ' starts the properties dialog. Choosing 'Resources' shows Interrupt and Memory Range.

The newest information on hardware problems can always be found on our website www.rme-audio.com, section FAQ, Hardware Alert: about incompatible hardware.

The dialog 'New hardware component found' does not appear:

- Check whether the CardBus card is completely inserted into the PCMCIA slot, or the PCI interface is correctly inserted in the PCI slot.

The card and drivers have been installed correctly, but playback does not work:

- Check whether the Hammerfall DSP appears in the Device Manager. If the ' Hammerfall DSP' device has a yellow exclamation mark, then there is an address or interrupt conflict.
- Even if there is no yellow exclamation mark, it's still worth checking the 'Resources' tab.

18. Diagrams

18.1 Channel Routing ASIO at 96 kHz

This diagram shows the signal paths in ASIO double speed mode (88.2 / 96 kHz). The devices available via the ASIO driver have been designed to avoid conflicts in normal operation. Record and playback are identical.

Device: The device name in the audio application SR: Sample Rate
 Device name code: Channel in ASIO host, interface, Digiface, card number

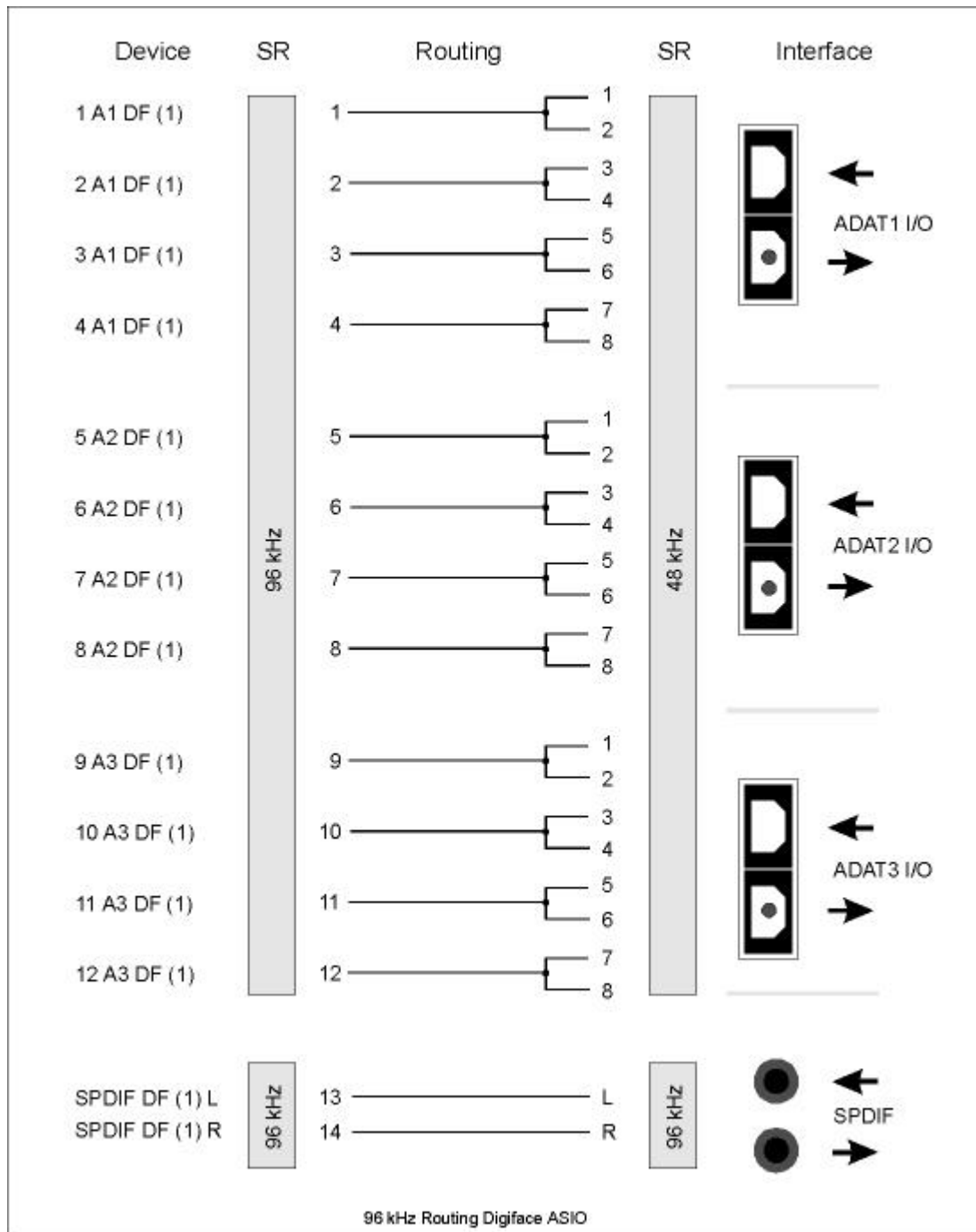

18.2 Channel Routing MME at 96 kHz

This diagram shows the signal paths in MME double speed mode (88.2 / 96 kHz). The devices available via the MME wave driver have been designed to avoid conflicts in normal operation, which is why channels 5, 6, 7 and 8 of the ADAT device have been omitted. Record and play-back are identical.

Device: The device name in the audio application

SR: Sample Rate

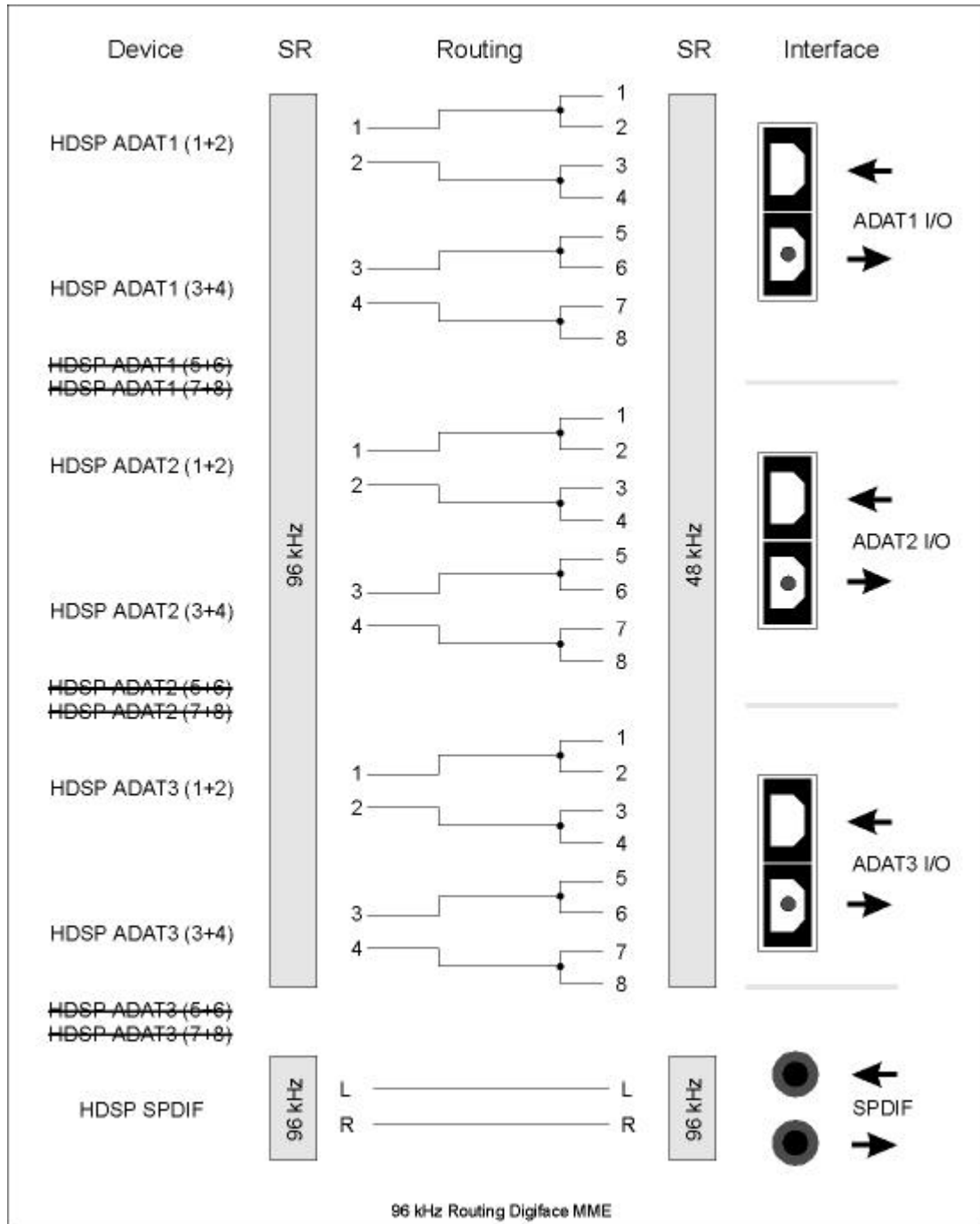

User's Guide



Digiface

- ▶ **Driver Installation and Operation – Mac OS X**

19. Driver and Flash Update

19.1 Driver Installation

First fit the card (see 5. Hardware Installation), then switch on the computer and install the drivers from the RME Driver CD. The driver file is located in the folder **Hammerfall DSP**. Installation works automatically by a double-click on the file **hdsp.mpkg**.

RME recommends to download the latest driver version from the RME website! If done, the procedure is as follows:

Double-click onto **hdsp_xx.gz** to expand the archive file to **hdsp_xx.tar** and the folder **HDSP_xx**, which includes the driver file **hdsp.mpkg**. Installation works automatically by a double-click on this file.

During driver installation the programs **Settings** and **Mixer** (TotalMix) will also be installed. Both programs start automatically as soon as a HDSP system is detected. They stay in the dock when exited, and remove themselves automatically from the dock when the HDSP system is removed.

Reboot the computer when installation is done.

19.2 Driver Update

In case of a driver update it's not necessary to remove the old driver first, it will be overwritten during the installation.

Exception: driver updates from version <1.6. Remove the former Settings dialog and TotalMix from the Login Items, and delete both files from your hard drive!

This driver version did not have the features AutoLoad, Dock Lock and AutoRemove. Therefore one has to make sure that both programs have been removed from the system, to prevent the old Settings dialog and TotalMix from being loaded.

19.3 Flash Update

The Flash Update Tool updates HDSP PCI cards or CardBus cards to the latest version. It requires an already installed driver.

Start the program **HDSP Flash**. The Flash Update Tool displays the current revision of the HDSP interface, and whether it needs an update or not. If so, then please manually select if a PCI card (desktop computer) or a CardBus card (laptop) shall be flashed. Next simply press the 'Update' button. A progress bar will indicate when the flash process is finished. The bar moves slowly first (program), then faster (verify).

If more than one interface card is installed, all cards can be flashed by changing to the next tab and repeating the process.

After the update the PCI/CardBus cards need to be resettet. This is done by powering down and shutting off the PC. A warm boot is not enough!

PCI card revision 1.8 or up (black PCB), CardBus with 6-pin FireWire connector

When the update fails (status: failure), the card's second BIOS will be used from the next cold boot on (Secure BIOS Technology). Therefore the card stays fully functional. The flash process should then be tried again on a different computer.

All other PCI cards, and CardBus with 15-pin flat connector

When the update fails (status: failure) the flash process should be repeated several times, until no error message occurs anymore. If the failure message is displayed nonetheless, the interface will most probably no longer work when the computer is switched off and on again. The interface then has to be re-programmed at the factory. We have invested a lot of work to prevent the system from getting in this state. If it happens despite our efforts, the best advice we can give is to not switch off the computer! As long as it is not switched off the old programming of the PCI/CardBus interface will stay active, and you can continue to work with the system using the old drivers

20. Configuring the Digiface

20.1 Settings Dialog

Configuring the Digiface is done via its own settings dialog. The panel 'Settings' can be opened by clicking on the hammer icon in the dock. The mixer of the Hammerfall DSP System, TotalMix, can be opened by clicking on the mixer icon in the dock.

The Hammerfall DSP's hardware offers a number of helpful, well thought-of practical functions and options which affect how the card operates - it can be configured to suit many different requirements. The following is available in the 'Settings' dialog:

- Input selection
- Output mode
- Output channel status
- Synchronization behaviour
- Input and output status display

Any changes performed in the Settings dialog are applied immediately - confirmation (e.g. by exiting the dialog) is not required. However, settings should not be changed during playback or record if it can be avoided, as this can cause unwanted noises.

The status displays at the bottom of the dialog box give the user precise information about the current status

of the system, and the status of all digital signals. *SyncCheck* indicates whether there is a valid signal (Lock, No Lock) for each input (Word Clock, ADAT, SPDIF), or if there is a valid *and* synchronous signal (Sync). The *AutoSync Reference* display shows the input and frequency of the current sync source.

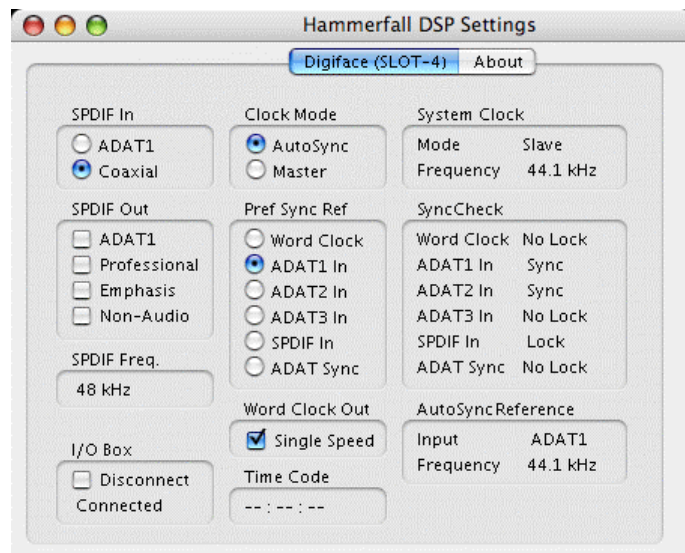

SPDIF In

Defines the input for the SPDIF signal. 'Coaxial' relates to the RCA socket, 'ADAT1' to the optical TOSLINK input.

SPDIF Out

The SPDIF output signal is constantly available at the phono plug. After selecting 'ADAT1' it is also routed to the optical TOSLINK output. For further details about the settings 'Professional', 'Emphasis' and 'Non-Audio', please refer to chapter 26.2.

SPDIF Freq.

Displays the sample rate of the signal at the SPDIF input.

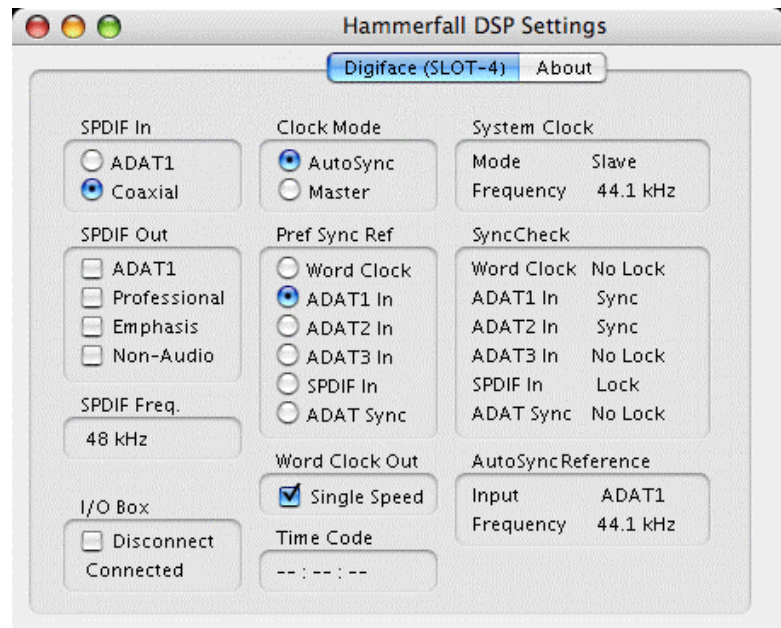

I/O Box

Disconnect interrupts the communication between I/O-box and PCI or CardBus card. In case the Digiface has been configured using the Settings dialog and TotalMix, *Disconnect* allows to use it Stand-Alone (without a connected computer), after a power supply has been attached.

The status display below shows the current state of the I/O-box:

- Error:* I/O-box not connected or missing power
- Detected:* The interface has found an I/O-box and tries to load the firmware
- Connected:* Communication between interface and I/O-box operates correctly
- Disconnected:* Communication between interface and I/O-box has been interrupted, I/O-box continues operation

Clock Mode

The unit can be configured to use its internal clock source (Master), or the clock source pre-defined via *Pref. Sync Ref* (AutoSync).

Pref Sync Ref

Used to pre-select the desired clock source. If the selected source isn't available, the unit will change to the next available one. The current clock source and sample rate is displayed in the *AutoSync Ref* display.

The automatic clock selection checks and changes between the clock sources Word Clock, ADAT optical, ADAT Sync and SPDIF.

Word Clock Out

The word clock output signal usually equals the current sample rate. Selecting *Single Speed* causes the output signal to always stay within the range of 32 kHz to 48 kHz. So at 96 kHz sample rate, the output word clock is 48 kHz.

Time Code

Time Code from the input ADAT Sync. Not available for the Digiface under OS X.

System Clock

Shows the current clock state of the HDSP system. The system is either Master (using its own clock) or Slave (see AutoSync Ref).

SyncCheck

SyncCheck indicates whether there is a valid signal (Lock, No Lock) for each input (Word Clock, ADAT1-3, ADAT Sync, SPDIF), or if there is a valid *and* synchronous signal (Sync). The *AutoSync Reference* display shows the input and frequency of the current sync source.

20.2 Clock Modes - Synchronisation

In the digital world, all devices are either the 'Master' (clock source) or a 'Slave' synchronized to the master. Whenever several devices are linked within a system, there must always be a single master clock. The Hammerfall DSP's intelligent clock control is very user-friendly, being able to switch between clock modes automatically. Selecting **AutoSync** will activate this mode.

In AutoSync mode, the system constantly scans all digital inputs for a valid signal. If this signal corresponds with the current playback sample rate, the card switches from the internal quartz (AutoSync Ref displays 'Master') to a clock generated from the input signal (AutoSync Ref displays 'Slave'). This allows on-the-fly recording, even during playback, without having to synchronize the card to the input signal first. It also allows immediate playback at any sample rate without having to reconfigure the card.

AutoSync guarantees that normal record and record-while-play will always work correctly. In certain cases however, e.g. when the inputs and outputs of a DAT machine are connected directly to the Hammerfall DSP, AutoSync may cause feedback in the digital carrier, so synchronization breaks down. To remedy this, switch the HDSP's clock mode over to 'Master'.



Remember that a digital system can only have one master! If the HDSP's clock mode is set to 'Master', all other devices must be set to 'Slave'.

The Hammerfall DSP's ADAT optical input and the SPDIF input operate simultaneously. Because there is no input selector however, the HDSP has to be told which of the signals is the sync reference (a digital device can only be clocked from a *single* source). This is why the system has been equipped with automatic clock source selection, which adopts the first available input with a valid digital signal as the clock reference input. The input currently used as sync reference is shown in the *AutoSync Ref* status field, together with its sample frequency.

Via *Pref. Sync Ref* (preferred synchronization reference) a preferred input can be defined. As long as the card sees a valid signal there, this input will be designated as the sync source, otherwise the other inputs will be scanned in turn. If none of the inputs are receiving a valid signal, the card automatically switches clock mode to 'Master'.

To cope with some situations which may arise in studio practice, setting 'Pref Sync Ref' is essential. One example: An ADAT recorder is connected to the ADAT1 input (ADAT1 immediately becomes the sync source) and a CD player is connected to the SPDIF input. Try recording a few samples from the CD and you will be disappointed. Few CD players can be synchronized. The samples will inevitably be corrupted, because the signal from the CD player is read with the (wrong) clock from the ADAT i.e. out of sync. In this case, 'Pref Sync Ref' should be temporarily set to SPDIF.

If several digital devices are to be used simultaneously in a system, they not only have to operate with the same sample frequency but also be synchronous with each other. This is why digital systems always need a single device defined as 'master', which sends the same clock signal to all the other ('slave') devices.

RME's exclusive **SyncCheck** technology (first implemented in the Hammerfall) enables an easy to use check and display of the current clock status. The 'SyncCheck' field indicates whether no signal ('No Lock'), a valid signal ('Lock') or a valid *and* synchronous signal ('Sync') is present at each of the digital clock source inputs. The *AutoSync Reference* display shows the current sync source and the measured frequency.

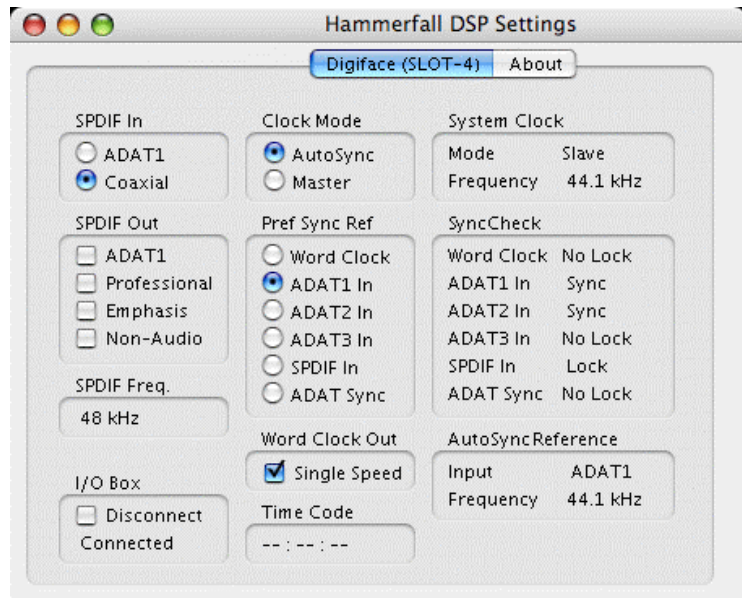

In practice, SyncCheck provides the user with an easy way of checking whether all digital devices connected to the system are properly configured. With SyncCheck, finally anyone can master this common source of error, previously one of the most complex issues in the digital studio world.

An example to illustrate this: The ADAT1 and ADAT2 inputs are receiving signals from a digital mixing desk that has been set to clock mode 'Internal' or 'Master'. An ADAT recorder is connected to the ADAT3 input. The Hammerfall DSP is set to AutoSync mode. As expected, SyncCheck shows that the ADAT1 and ADAT2 inputs are in sync (as they are driven by the same clock from the mixing desk), but shows 'Lock' instead of 'Sync' for the ADAT3 input. Because the ADAT recorder is not receiving any signals from HDSP or from the mixer, it will generate its own clock at a rate which is (almost) the same as the sample frequency of the mixing desk - but not identical.

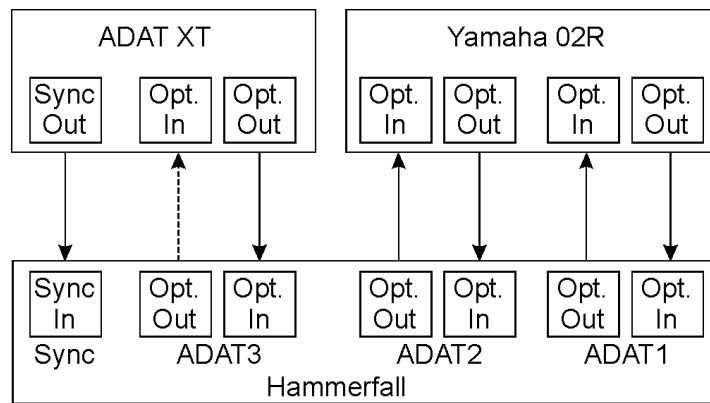

Remedy: To drive the ADAT recorder from its digital input, set it to slave mode (DIG), and connect the input to the HDSP's ADAT3 output. The Hammerfall DSP is already in sync with the mixing desk, so it will send an identical (synchronous) signal to ADAT3 out. The ADAT recorder will lock onto this, its output will also be in sync. The signal from the ADAT recorder is now fully in sync with the signals from the mixing desk.

Thanks to its AutoSync technique and lightning fast PLLs, the HDSP is not only capable of handling standard frequencies, but also any sample rate between 28 and 103 kHz. Even the word clock input, which most users will use in varispeed operation, allows any frequency between 28 kHz and 103 kHz.

At 88.2 or 96 kHz: If one of the ADAT inputs has been selected in 'Pref Sync Ref', the sample frequency shown in the field *SPDIF Freq.* differs from the one shown in 'AutoSync Ref'. The card automatically switches to S/MUX mode here, because ADAT optical inputs and outputs are only specified up to 48 kHz. Data from/to a single input/output is spread over two channels, the internal frequency stays at 44.1 or 48 kHz. In such cases, the ADAT sample frequency is only half the SPDIF frequency.

21. Mac OS X FAQ

21.1 Round about Driver Installation

The driver with the file suffix **gz** provided by RME is a compressed **TAR** archive. TAR bundles multiple files and folders into one file, but does not save memory space nor download time. Both TAR and gz are supported natively by OS X, a double click on the file is all you need to do.

Older browsers do not recognize **gz** as an archive, loading the file as a document. This results in a cryptic looking text within the browser window. Downloading the file can be done via the right mouse key, **Save Target as**. Despite this procedure, some older browsers like Netscape 4.78 will not save the file correctly - the archive will be corrupted.

The driver consists of a package file (pkg), which contains various folders and files, similar to TAR. A double click will start the OS X installer. To save you the hassle of installing both audio and MIDI drivers separately, the HDSP driver contains an additional **meta package** (mpkg), that points to the single packages. Those single packages are not shown in the Finder, as they reside within the invisible folder '.contained_packages'. Only the mpkg is visible. Important: an installation can only be done with the **complete** folder. If only the mpkg is copied to a different place, it will not find the single driver packages!

The actual audio driver appears as a kernel extension file. The installer copies it to **>System/Library/ Extensions<**. Its name is **HammerfallDSP.kext**. It is visible in the Finder, allowing you to verify date and driver version. Yet, in fact this again is a folder containing subdirectories and files.

Nonetheless, this 'driver file' can be removed by simply dragging it to the trash bin. This can be helpful in case a driver installation fails. An incomplete installation can currently (10.3.2) only be detected indirectly: The installation routine does not open a message window with a note about a restart of the computer. This indicates that the driver file was not copied and the driver was not installed!

Several users have observed that the installation routine occasionally stops and no longer works correctly. This can be fixed by removing the corresponding extension file prior to installation. In some cases, also (or only) a repair of the **disk permission** will help.

We have also received reports saying the driver update could not be installed on the system disk - shown red crossed during the installation. Repairing permission may also help here. If not, we're sorry, but have to recommend to contact Apple. Our driver has no knowledge of folders, disks etc., the installation is handled completely by the OS X installer.

21.2 MIDI doesn't work

In some cases MIDI does not work after the installation of the HDSP driver. To be precise, applications do not show an installed MIDI port. The reason for this is usually visible within the **Audio MIDI Setup**. It displays no RME MIDI device, or the device is greyed out and therefore inactive. Mostly, removing the greyed out device and searching for MIDI devices again will solve the problem. If this does not help, we recommend manual removal of the MIDI driver and reinstallation of the complete driver. Otherwise repairing permissions may help.

The HDSP MIDI driver is a plugin. During installation it will be copied to **>Library/ Audio/ MIDI Drivers<**. It's name is **Hammerfall DSP MIDI.plugin**. The file can be displayed in the Finder and also be removed by simply dragging it to the trash bin.

21.3 Supported Sample Rates

RME's Mac OS X driver supports all sampling frequencies provided by the hardware. Besides **96 kHz** this also includes **32 kHz** and **64 kHz**.

But not every software will support all the hardware's sample rates. For example Spark does not display 32 kHz and 64 kHz. The hardware's capabilities can easily be verified in the **Audio MIDI Setup**. Select **Audio devices** under **Properties of:** and choose the Hammerfall DSP. A click on **Format** will list the supported sample frequencies.

If the unit is in clock mode **Master**, selecting a sample rate will immediately set the device to this frequency, which can be verified in the HDSP's settings dialog (System Clock). **Format** thus allows you to activate any sampling frequency quickly and easily.

21.4 Repairing Disk Permissions

Repairing permission can solve problems with the installation process - plus many others. To do this, launch **Disk Utility** located in **Utilities**. Select your system drive in the drive/volume list to the left. The **First Aid** tab to the right now allows you to check and repair disk permissions.

21.5 PCI card and PCI slot compatibility

Unfortunately not every RME card will work in every PCI slot of an Apple computer. To our knowledge, the current Hammerfall DSP systems can be used in any PCI slot of all G4 and G5 models. In case additional PCI cards of any manufacturer are used, it might happen that the RME card is no longer found by the system. Swapping cards between slots can be helpful in this case.

21.6 Various Information

The driver requires 10.2.8 or higher. Older versions of OS X are not and will not be supported.

Via **>System Preferences/ Audio-MIDI Setup<** the hardware can be configured for the system wide usage. Programs that don't support card or channel selection will use the device selected as **Standard-Input** and **Standard-Output**. (Soundstudio, Mplayer, Amplitude etc.).

In the lower part of the window, the audio hardware's capabilities are shown and can be changed in some cases. On the record side no changes are possible. Programs that don't support channel selection will always use channels 1/2, the first stereo pair. To access other inputs use the following workaround with TotalMix: route the desired input signal to output channels 1/2. Hold the Ctrl key down and click on the labels A1_1 and A1_2 in the third row. Their labels turn red, the internal loop mode is active. Result: the desired input signal is now available at input channel 1/2, without further delay/latency.

Since OS X 10.3 playback can be configured freely and to any of the available playback channels. This is done via **Speaker Setup**. Even multichannel playback (Surround, DVD Player) can be set up easily.

Multicard Operation

OS X supports more than one audio device. Their simultaneous usage within one program had been limited to Motu's Digital Performer until 10.3.9. Since 10.4 (Tiger) Core Audio offers the function **Aggregate Devices**, which allows to combine several devices into one, so that a multi-device operation is now possible with any software.

The Hammerfall DSP driver adds a number to each unit, so they are fully accessible in any multicard-capable software.

22. Hotline – Troubleshooting

The newest information can always be found on our website www.rme-audio.com, section Support, Macintosh OS.

Playback works, but record doesn't:

- Check that there is a valid signal at the input.
- Check whether the Hammerfall DSP has been selected as recording device in the audio application.

Crackle during record or playback:

- Increase the number and size of buffers in the application.
- Try different cables to rule out any defects here.

The card and drivers have been installed correctly, but playback does not work:

- Is Hammerfall DSP listed in the System Profiler/PCI? (Vendor 10EE, Device ID 3FC5).
- Has Hammerfall DSP been selected as current playback device in the audio application?

23. Diagram: Channel Routing at 96 kHz

This diagram shows the signal paths in double speed mode (88.2 / 96 kHz). The last four channels of the ADAT port have no function anymore in Core Audio, but are used by the hardware to transmit data at double sample rate.

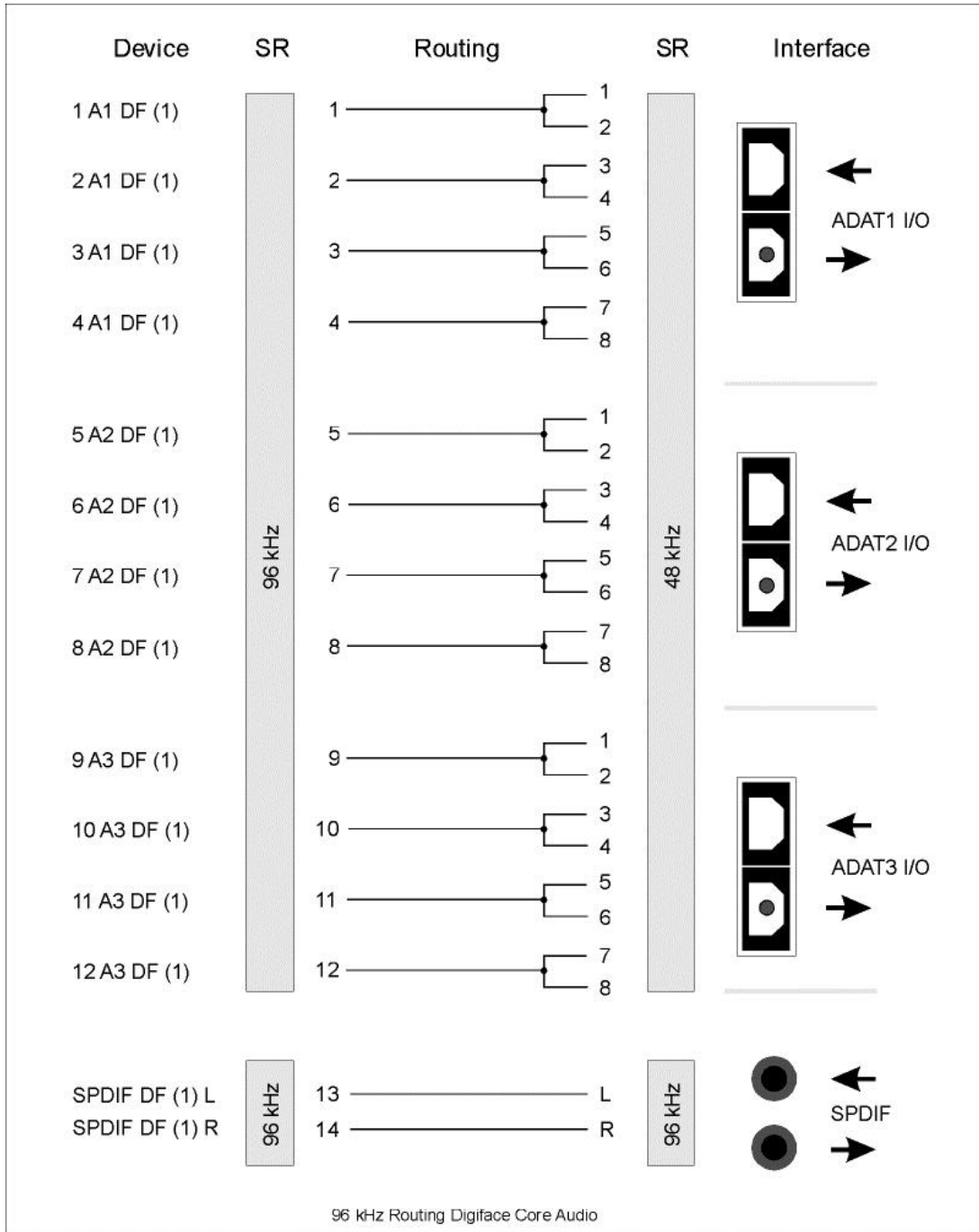



User's Guide



Digiface

- ▶ **Disconnect Mode, Connections and TotalMix**

24. Disconnect Mode

RME's exclusive Disconnect mode lets you adjust level, input selection and signal mix via your computer, and simply detach the Digiface afterwards. With this, a stand-alone operation of the Digiface gets possible. When the Digiface has been configured using Settingsdialog and TotalMix, it won't lose those settings after detaching it from the computer. Provided, the Digiface is operated with an external power supply, because the Digiface (as all HDSP I/O-boxes) does not contain memory, so all settings get lost upon power-off.

If you do not need to record or playback audio with your computer, the Digiface can be used in a fixed configuration, for example as:

- SPDIF / ADAT / SPDIF format converter with monitoring
- SPDIF AD- or DA-converter
- Mixer / patchbay / distributor analog and digital
- Headphone mixer
- ADAT Matrix Router
- what ever you just need!

The unit can also stay connected to a desktop computer, receiving its power from there. The Disconnect mode will then cause the unit to be isolated from the computer, no longer be available to any software or other changes – an interesting security application.

25. Analog Output Headphones

Channels 27/28 of the Digiface are available on the front via one 1/4" unbalanced TRS jack (stereo output). This output uses a hi-grade converter, therefore maintains a high signal to noise ratio and low distortion (THD+N).

The output is a special low impedance type, ready to be used with headphones. But it can also be used as high-quality (yet unbalanced) stereo Line output.

Like all other outputs, the level of channels 27/28 can also be controlled by TotalMix. The monitoring performed on 19/20 of any input or playback channels (submix, like factory presets 1 and 2) is also controlled from TotalMix.

In case the output should operate as line output, an adapter TRS plug to RCA phono plugs, or TRS plug to TS plugs is required.

The pin assignment follows international standards. The left channel is connected to the tip, the right channel to the ring of the TRS jack/plug.

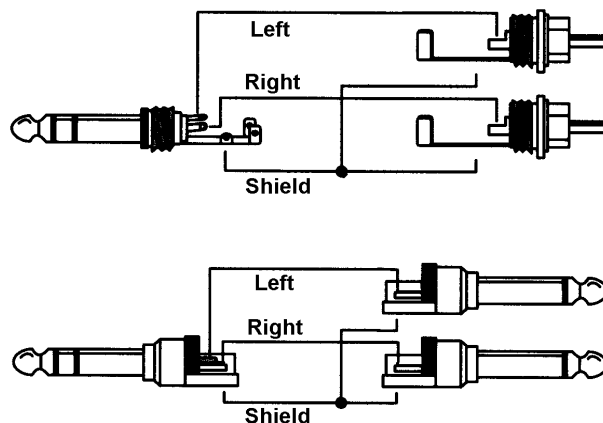

26. Digital Connections

26.1 ADAT

The ADAT optical input of the HDSP system is fully compatible with all ADAT optical outputs. RME's unsurpassed Bitclock PLL prevents clicks and drop outs even in extreme varipitch operation, and guarantees a fast and low jitter lock to the digital input signal. A usual TOSLINK cable is sufficient for connection. More information on Double Speed (S/MUX) can be found in chapter 34.3.

ADAT 1 In

Interface for a device sending an ADAT signal to the Digiface. Carries the channels 1 to 8. When receiving a Double Speed signal, this input carries the channels 1 to 4. Can also be used as SPDIF optical input.

ADAT 1 Out

Interface for a device receiving an ADAT signal from the Digiface. Transmits channels 1 to 8. When sending a Double Speed signal, this port carries channels 1 to 4. Can also be used as SPDIF optical output.

ADAT 2/3 In

Interface for a device sending an ADAT signal to the Digiface. Carries the channels 9 to 24. When receiving a Double Speed signal, this input carries the channels 5 to 8 and 9 to 12.

ADAT 2/3 Out

Interface for a device receiving an ADAT signal from the Digiface. Transmits channels 9 to 24. When sending a Double Speed signal, this port carries channels 5 to 8 and 9 to 12.

26.2 SPDIF

Input

The SPDIF input is configured in the Settings dialog, available by a click on the hammer symbol in the Task Bar's system tray. The HDSP system accepts all commonly used digital sources as well as SPDIF and AES/EBU. Channel status and copy protection are ignored.

To receive signals in AES/EBU format, an adapter cable is required. Pins 2 and 3 of a female XLR plug are connected individually to the two pins of a phono plug. The cable shielding is only connected to pin 1 of the XLR - not to the phono plug.

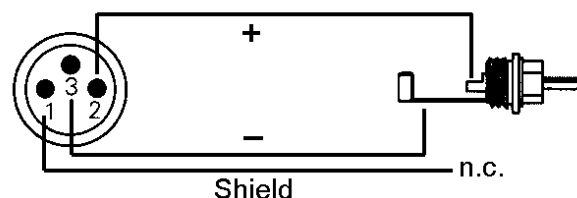

The ground-free design, with transformers for coaxial digital inputs and outputs, offers a trouble-free connection of all devices along with perfect hum rejection and full AES/EBU compatibility.

Output

In SPDIF mode, identical signals are available at both the optical and the coaxial output. An obvious use for this would be to connect two devices, i.e. using the HDSP as a splitter (distribution 1 on 2).

Apart from the audio data itself, digital signals in SPDIF or AES/EBU format have a header containing channel status information. False channel status is a common cause of malfunction. The HDSP system ignores the received header and creates a totally new one for its output signal.



Note that in record or monitor modes, set emphasis bits will disappear. Recordings originally done with emphasis should always be played back with the emphasis bit set!

This can be done by selecting the *Emphasis* switch in the Settings dialog (field *SPDIF Out*). This setting is updated immediately, even during playback.

Note: Recordings with (pre-) emphasis show a treble boost (50/15 μ s), which has to be compensated at playback. Therefore, when selecting *Emphasis* all analog outputs will be processed by a treble filter based on 50/15 μ s, which sounds like a high cut.

The Digiface's new output header is optimized for largest compatibility with other digital devices:

- 32 kHz, 44.1 kHz, 48 kHz, 88.2 kHz, 96 kHz depending on the current sample rate
- Audio use, Non-Audio
- No Copyright, Copy Permitted
- Format Consumer or Professional
- Category General, Generation not indicated
- 2-channel, No Emphasis or 50/15 μ s
- Aux bits Audio Use

Professional AES/EBU equipment can be connected to the Digiface thanks to the transformer-balanced coaxial output, and the 'Professional' format option with doubled output voltage. Output cables should have the same pinout as those used for input (see above), but with a male XLR plug instead of a female one.



Note that most consumer HiFi equipment (with optical or phono SPDIF inputs) will only accept signals in 'Consumer' format!

The audio bit in the header can be set to 'Non-Audio'. This is often necessary when Dolby AC-3 encoded data is sent to external decoders (surround-sound receivers, television sets etc. with AC-3 digital inputs), as these decoders would otherwise not recognize the data as AC-3.

26.3 Word Clock

The Digiface's word clock input is a high impedance type (not terminated).

Thanks to a low impedance, but short circuit proof output, the Digiface delivers 4 Vpp to 75 Ohms. For wrong termination with 2 x 75 Ohms (37.5 Ohms), there are still 3.3 Vpp at the output.

Selecting *Single Speed* in the Settings dialog causes the output signal to always stay within the range of 32 kHz to 48 kHz. So at 96 kHz sample rate, the output word clock is 48 kHz.

26.4 MIDI

The Digiface offers two MIDI I/O via two 5-pin DIN jacks each. The MIDI ports are added to the system by the driver. Using MIDI capable software, these ports can be accessed under the name *HDSP MIDI*. Using more than one Digiface, the operating system adds a consecutive number to the port name, like *HDSP MIDI In (3)* etc.

The MIDI In port is available for both GSIF (GSIF-2 Low Latency) and standard MME MIDI simultaneously.

Note: The MIDI input LED displays any kind of MIDI activity, including MIDI Clock, MTC and Active Sensing. The latter is sent by most keyboards every 0.3 seconds.

27. Word Clock

27.1 Technical Description and Usage

In the analog domain one can connect any device to another device, a synchronization is not necessary. Digital audio is different. It uses a clock, the sample frequency. The signal can only be processed and transmitted when all participating devices share the same clock. If not, the signal will suffer from wrong samples, distortion, crackle sounds and drop outs.

AES/EBU, SPDIF and ADAT are self-clocking, an additional word clock connection in principle isn't necessary. But when using more than one device simultaneously problems are likely to happen. For example any self-clocking will not work in a loop cabling, when there is no 'master' (main clock) inside the loop. Additionally the clock of all participating devices has to be synchronous. This is often impossible with devices limited to playback, for example CD players, as these have no SPDIF input, thus can't use the self clocking technique as clock reference.

In a digital studio synchronisation is maintained by connecting all devices to a central sync source. For example the mixing desk works as master and sends a reference signal, the word clock, to all other devices. Of course this will only work as long as all other devices are equipped with a word clock or sync input, thus being able to work as slave (some professional CD players indeed have a word clock input). Then all devices get the same clock and will work in every possible combination with each other.



Remember that a digital system can only have one master!

27.2 Cabling and Termination

Word clock signals are usually distributed in the form of a network, split with BNC T-adapters and terminated with resistors. We recommend using off-the-shelf BNC cables to connect all devices, as this type of cable is used for most computer networks. You will find all the necessary components (T-adapters, terminators, cables) in most electronics and/or computer stores.

Ideally, the word clock signal is a 5 Volt square wave with the frequency of the sample rate, of which the harmonics go up to far above 500 kHz. To avoid voltage loss and reflections, both the cable itself and the terminating resistor at the end of the chain should have an impedance of 75 Ohm. If the voltage is too low, synchronization will fail. High frequency reflection effects can cause both jitter and sync failure.

Unfortunately there are still many devices on the market, even newer digital mixing consoles, which are supplied with a word clock output that can only be called unsatisfactory. If the output breaks down to 3 Volts when terminating with 75 Ohms, you have to take into account that a device, of which the input only works from 2.8 Volts and above, does not function correctly already after 3 meter cable length. So it is not astonishing that because of the higher voltage, word clock networks are in some cases more stable and reliable if cables are not terminated at all.

Ideally all outputs of word clock delivering devices are designed with very low impedance, but all word clock inputs with high impedance, in order to not weaken the signal on the chain. But there are also negative examples, when the 75 Ohms are built into the device and cannot be switched off. In this case the network load is often 2 x 75 Ohms, and the user is forced to buy a special word clock distributor. Note that such a device is generally recommended for bigger studios.

The word clock input of the Hammerfall DSP is a high-impedance type ensuring maximum flexibility, and is therefore not terminated. If normal termination is necessary (e.g. because Hammerfall DSP is the last device in the chain), simply connect a T-adapter to its BNC input jack, connect the cable supplying the word clock signal to one arm of the T-adapter and terminate the other with a 75 Ohm resistor (as a short BNC plug).

In case Hammerfall DSP resides within a chain of devices receiving word clock, plug a T-adapter into Hammerfall DSP's BNC input jack and the cable supplying the word clock signal to one end of the adapter (as above), but connect the free end to the next device in the chain via a further BNC cable. The last device in the chain should be terminated using another T-adapter and a terminator plug as described in the previous paragraph.

27.3 Operation

The Digiface's word clock input is active when *Pref. Sync Ref* in the Settings dialog has been set to *Word Clock*, the clock mode *AutoSync* has been activated, and a valid word clock signal is present. The signal at the BNC input can be Single or Double Speed, the Hammerfall DSP automatically adapts to it. As soon as a valid signal is detected, the green WC LED on the front (DIGITAL STATE) is lit, and the Settings dialog shows either Lock or Sync (see chapter 34.1).

As soon as there is a valid signal at the BNC jack, *AutoSync Ref* will display *Word*. This message has the same function as the green Lock LED on the front, but appears on the monitor, i.e. the user can check immediately whether a valid word clock signal is present and is currently being used.

In the line *Freq.*, the *AutoSync Ref* shows the frequency of the reference signal, measured by the hardware. In this case the frequency of the current wordclock signal is measured and displayed.

The word clock output of the Hammerfall DSP is constantly active, providing the current sample frequency as word clock signal. As a result, in Master mode the provided word clock is defined by the currently used software. In Slave mode, the provided frequency is identical to the one present at the currently chosen clock input. When the current clock signal fails, the Hammerfall DSP switches to Master mode and adjusts itself to the next, best matching frequency (44.1 kHz, 48 kHz etc.).

28. TotalMix: Routing and Monitoring

28.1 Overview

The Digiface includes a powerful digital real-time mixer, the *Hammerfall DSP mixer*, based on RME's unique, sample-rate independent **TotalMix** technology. It allows for practically unlimited mixing and routing operations, with all inputs and playback channels simultaneously, to any hardware outputs.

Here are some typical applications for TotalMix:

- Setting up delay-free submixes (headphone mixes). The Digiface allows for up to 14 (!) fully independent stereo submixes. On an analog mixing desk, this would equal 28 (!) Aux sends.
- Unlimited routing of inputs and outputs (free utilisation, patchbay functionality).
- Distributing signals to several outputs at a time. TotalMix offers state-of-the-art splitter and distributor functions.
- Simultaneous playback of different programs using only one stereo output. The ASIO multi-client driver allows to use several programs at the same time, but only on different playback channels. TotalMix provides the means to mix and monitor these on a single stereo output.
- Mixing of the input signal to the playback signal (complete ASIO Direct Monitoring). RME not only is *the* pioneer of ADM, but also offers the most complete implementation of the ADM functions.
- Integration of external devices. Use TotalMix to insert external effects devices, be it in the playback or in the record path. Depending on the current application, the functionality equals insert or effects send and effects return, for example as used during real-time monitoring when adding some reverb to the vocals.

Every single input channel, playback channel and hardware output features a Peak and RMS level meter, calculated in hardware (hardware output is Peak only). These level displays are very useful to determine the presence and routing destinations of the audio signals.

For a better understanding of the TotalMix mixer you should know the following:

- As shown in the block diagram (next page), the record signal usually stays un-altered. TotalMix does not reside within the record path, and does not change the record level or the audio data to be recorded (exception: loopback mode).
- The hardware input signal can be passed on as often as desired, even with different levels. This is a big difference to conventional mixing desks, where the channel fader always controls the level for all routing destinations simultaneously.
- The level meter of inputs and playback channels are connected pre-fader, to be able to visually monitor where a signal is currently present. The level meters of the hardware's outputs are connected post-fader, thus displaying the actual output level.

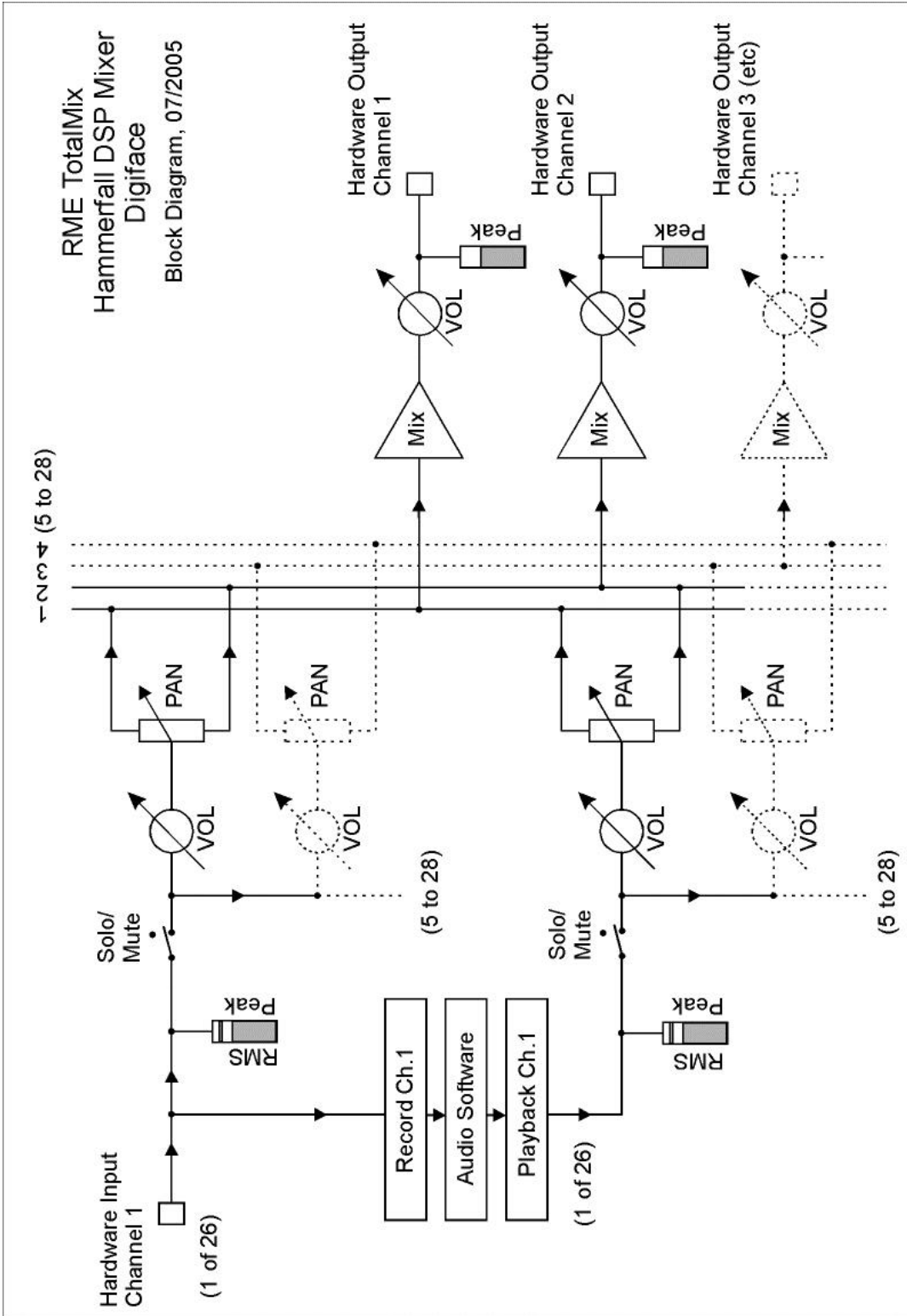

28.2 The User Interface

The visual design of the TotalMix mixer is a result of its capability to route hardware inputs and software playback channels to any hardware output. The Digiface provides 26 input channels, 26 software playback channels, and 28 hardware output channels:

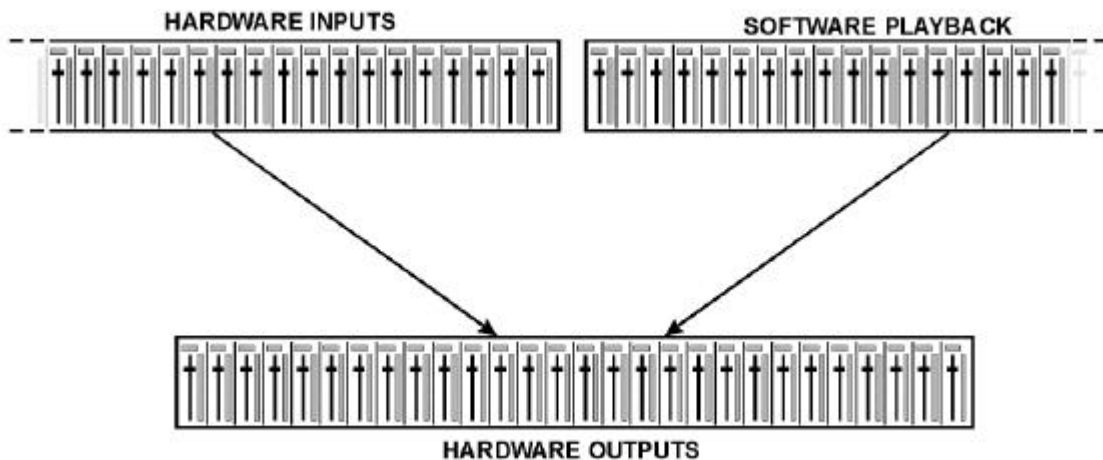

52 channels don't fit on the screen side by side, neither does such an arrangement provide a useful overview. The input channel should be placed above the corresponding output channel. Therefore, the channels have been arranged as known from an *Inline* desk, so that the row *Software Playback* equals the *Tape Return* of a real mixing desk:

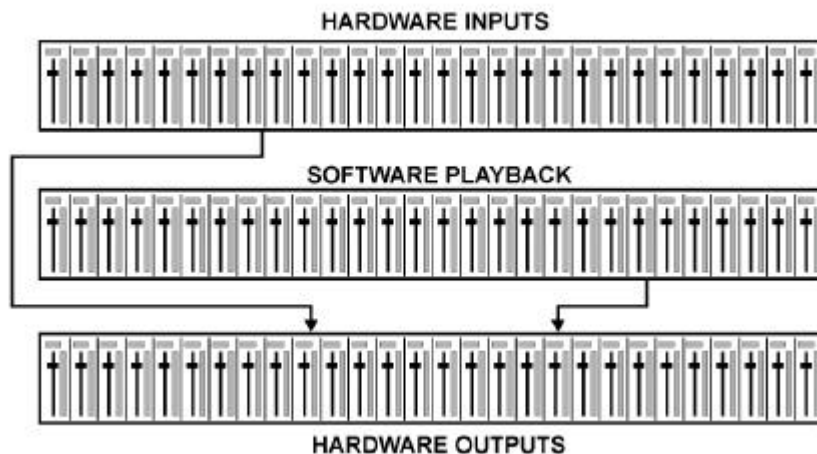

- Top row: Hardware inputs. The level shown is that of the input signal, i. e. fader independent. Via fader and routing field, any input channel can be routed and mixed to any hardware output (bottom row).
- Middle row: Playback channels (playback tracks of the audio software). Via fader and routing field, any playback channel can be routed and mixed to any hardware output (third row).
- Bottom row (third row): Hardware outputs. Here, the total level of the output can be adjusted. This may be the level of connected loudspeakers, or the necessity to reduce the level of an overloaded submix.

The following chapters explain step by step all functions of the user interface.

28.3 Elements of a Channel

A single channel consists of various elements:

Input channels and playback channels each have a mute and solo button.

Below there is the panpot, realized as indicator bar (L/R) in order to save space.

In the field below, the present level is displayed in RMS or Peak, being updated about every half a second. Overs (overload) are indicated here by an additional red dot.

Next is the fader with a level meter. The meter shows both peak values (zero attack, 1 sample is enough for a full scale display) by means of a yellow line, and mathematically correct RMS values by means of a green bar. The RMS display has a relatively slow time constant, so that it shows the average loudness quite well.

Below the fader, the current gain and panorama values are shown.

The white area shows the channel name. Selecting one or more channels is done by clicking on the white label which turns orange then. A click in the third row with pressed Ctrl-key activates internal loopback mode, the label turns red. A right mouse click opens a dialog to type in a new name.

The black area (routing field) shows the current routing target. A mouse click opens the routing window to select a routing target. The list shows all currently activated routings by checkmarks in front of the routing targets.



28.4 Tour de TotalMix

This chapter is a practical guide and introduction on how to use TotalMix and on how TotalMix works.

Starting up TotalMix the last settings are recalled automatically. When executing the application for the first time, a default file is loaded, sending all playback tracks 1:1 to the corresponding hardware outputs with 0 dB gain, and activating phones monitoring.

Hold down Ctrl and click on preset button 1 to make sure that factory preset 1 is loaded. The faders in the top row are set to maximum attenuation (called m.a. in the following), so there is no monitoring of the input channels. The **Submix View** is active, therefore for improved overview all outputs except Phones are greyed out. Additionally all faders are set to the routing target Phones. All faders of the middle row are set to 0 dB, so no matter on which channels a playback happens, the audio will be audible via the Phones output. Just try it!

We will now create a submix on output ADAT1 1/2. Please start a multitrack playback. In the third row, click on the channels of hardware output A1_1 or A1_2. The Submix View changes from Phones to A1_1/A1_2. Both the fader settings and the output levels of all other channels are still visible, but greyed out for improved orientation.

As soon as A1_1/A1_2 became active, all faders of the second row jumped to their bottom position – except those of playback channel 1/2. This is correct, because as mentioned above the factory preset includes a 1:1 routing. Click on A1_3/A1_4 and the faders above are the only active ones, same for A1_5/A1_6 and so on.

Back to A1_1/A1_2. Now you can change all the faders of all inputs and playback channels just as you like, thus making any input and playback signals audible via the outputs A1_1/A1_2. The panorama can be changed too. Click into the area above the fader and drag the green bar in order to set the panorama between left and right. The level meters of the third row display the level changes in real-time.

You see, it is very easy to set up a specific submix for whatever output: select output channel, set up fader and pans of inputs and playbacks – ready!

For advanced users sometimes it makes sense to work without Submix View. Example: you want to see and set up some channels of different submixes simultaneously, without the need to change between them all the time. Switch off the Submix View by a click on the green button. Now the black routing fields below the faders no longer show the same entry ('A1 1+2'), but completely different ones. The fader and pan position is the one of the individually shown routing destination.

In playback channel 1 (middle row), labeled Out 1, click onto the routing field below the label. A list pops up, showing a checkmark in front of 'A1 1+2' and 'Phones'. So currently playback channel 1 is sent to these two routing destinations. Click onto 'A1 7+8'. The list disappears, the routing field no longer shows 'A1 1+2', but 'A1 7+8'. Now move the fader with the mouse. As soon as the fader value is unequal m.a., the present state is being stored and routing is activated. Move the fader button to around 0 dB. The present gain value is displayed below the fader in green letters.

In the lower row, on channel 7, you can see the level of what you are hearing from output 7. The level meter of the hardware output shows the outgoing level. Click into the area above the fader and drag the mouse in order to set the panorama, in this case the routing between channels 7 and 8. The present pan value is also being displayed below the fader.

Please carry out the same steps for Out 2 now, in order to route it to output 8 as well.

In short: While editing the Submix A7/A8 you have direct access to other submixes on other channels, because their routing fields are set to different destinations. And you get a direct view of how their faders and panoramas are set up.

 *This kind of visual presentation is a mighty one, but for many users it is hard to understand, and it requires a deep understanding of complex routing visualizations. Therefore we usually re-recommend to work in **Submix View**.*

Often signals are stereo, i. e. a pair of two channels. It is therefore helpful to be able to make the routing settings for two channels at once. Hold down the Ctrl-key and click into the routing field of Out 3. The routing list pops up with a checkmark at 'A1 3+4'. Select 'A1 7+8'. Now, Out 4 has already been set to 'A1 7+8' as well.

When you want to set the fader to exactly 0 dB, this can be difficult, depending on the mouse configuration. Move the fader close to the 0 position and now press the Shift-key. This activates the fine mode, which stretches the mouse movements by a factor of 8. In this mode, a gain setting accurate to 0.1 dB is no problem at all.

Please set Out 4 to a gain of around -20 dB and the pan close to center. Now click onto the routing field. You'll now see three checkmarks, at 'A1 3+4', 'A1 7+8' and 'Phones'. Click onto 'SPDIF'. The window disappears, fader and pan jump to their initial values, the signal can now be routed to the SPDIF output. You can continue like this until all entries have got a checkmark, i. e. you can send the signal to all outputs simultaneously.

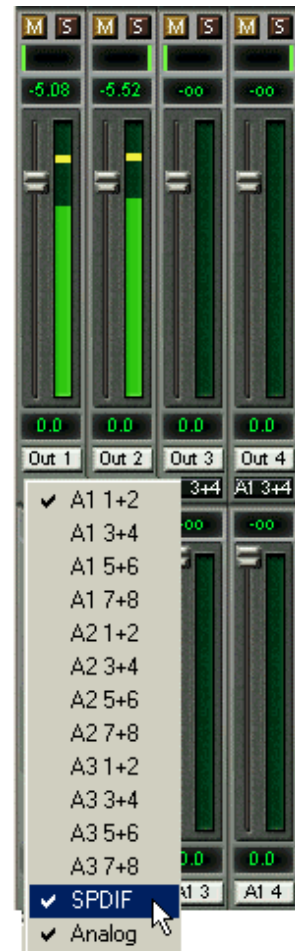

You will certainly have noticed that the signal at the outputs 7/8 did not change while you were routing channel 4 to other outputs and setting different gain values for those. With all analog and most digital mixing desks, the fader setting would affect the level for every routed bus - not so for TotalMix. TotalMix allows for setting all fader values individually. Therefore the faders and the panpots jump to the appropriate setting as soon as another routing is chosen.

Sometimes you will want the routings not to be independent. Let's say you have sent a signal to several submixes, and now want to change the signal's volume a bit on *all* these submixes. Dragging the faders by use of the right mouse button activates **Post Send** mode and causes all routings of the current input or playback channel to be changed in a relative way. Please note that the fader settings of all routings are memorized. So when pulling the fader to the bottom (maximum attenuation), the individual settings are back when you right click the mouse and pull the fader up. The individual settings get lost in m.a. position as soon as the fader is clicked with the left mouse button. As long as no single level is at m.a. position, the left mouse button can be used to change the current routing's gain.

The checkmarks are un-checked by moving the fader to m.a. This setting deactivates the routing...why route if there is no level? Click onto 'A1 7+8' in the routing window, pull the fader down, open the routing window again - the checkmark is gone.

The number of ADAT channels is reduced automatically when entering Double Speed mode (96 kHz). The display is adjusted accordingly, and all fader settings remain stored.

28.5 Submix View

Such a wide range of possibilities make it difficult to maintain the overview. Because practically all hardware outputs can be used for different submixes, as shown (up to 14 completely independent stereo submixes, 7 4-channel submixes etc.). And when opening the routing windows you might see an army of checkmarks, but you don't get an overview, i.e., how the signals come together and where. This problem is solved by **Submix View** mode. In this mode, all routing fields jump to the routing pair just being selected. You can then see immediately, which channels, which fader and pan settings make a submix (for example 'A1 7+8'). At the same time the Submix View simplifies setting up the mixer, as all channels can be set simultaneously to the same routing destination with just one click.

Changing to a different destination (output channel) is done in any routing field, or by a click on the desired output pair in the bottom row.

28.6 Mute und Solo

Mute operates pre-fader, thus mutes all currently active routings of the channel. As soon as any Mute button is pressed, the *Mute Master* button lights up in the Quick Access area. It allows to switch all selected mutes off and on again. You can comfortably make mute-groups or activate and deactivate several Mutes simultaneously.

The same holds true for the Solo and the *Solo Master* buttons. As with conventional mixing desks, Solo operates only for the output defined as **Monitor Main**, as a solo-in-place, post fader. As soon as one Solo button is pressed, the *Solo Master* button lights up in the Quick Access area. It allows to switch all selected Solos off and on again. You can comfortably make solo-groups or activate and deactivate several Solos simultaneously.

28.7 The Quick Access Panel

This section includes additional options, further improving the handling of TotalMix. The Master buttons for Mute and Solo have already been described, they allow for group-based working with these functions.

In the **View** section the single mixer rows can be made visible or invisible. If the inputs are not needed for a pristine playback mix, the whole upper row falls out of the picture after a click on the Input button. If the hardware outputs don't interest you either, the window can thus be reduced to the playback channels to save space. All combinations are possible and allowed.

As described earlier, **Submix** sets all routing windows to the same selection. Deactivating Submix automatically recalls the previous view. The mixer can be made smaller horizontally and vertically. This way TotalMix can be made substantially smaller and space-saving on the desktop/screen, if you have to monitor or set only a few channels or level meters.

The **Presets** are one of the mightiest and most useful features of TotalMix. Behind the eight buttons, eight files are hidden (see next chapter). These contain the complete mixer state. All faders and other settings follow the changing of preset(s) in real-time, just by a single mouse click. The **Save** button allows for storing the present settings in any preset. You can change back and forth between a signal distribution, complete input monitoring, a stereo and mono mix, and various submixes without any problem.

Also here, RME's love for details can be seen. If any parameter is being altered after loading a preset (e. g. moving a fader), the preset display flashes in order to announce that something has been changed, still showing which state the present mix is based on.

If no preset button is lit, another preset had been loaded via the **File** menu and **Open file**. Mixer settings can of course be saved the usual way, and have long file names.



Instead of single presets a complete bank of (8) presets can be loaded at once. Advantage: The names defined for the preset buttons will be stored and loaded automatically.

Up to three Hammerfall DSP systems can be used simultaneously. The **Unit** buttons switch between the systems (Digiface, Multiface II, Multiface, HDSP 9652 or HDSP 9632). Holding down Ctrl while clicking on button Unit 2 or Unit 3 will open another TotalMix window.

28.8 Presets

TotalMix includes eight factory presets, stored within the program. The user presets can be changed at any time, because TotalMix stores and reads the changed presets from the files **preset11.mix** to **preset81.mix**, located in Windows' hidden directory *>Documents and Settings, <Username>, Local Settings, Application Data, RME TotalMix<*. On the Mac the location is in the folder *>User, <Username>, Library / Preferences / Hammerfall DSP<*. The first number indicates the current preset, the second number the current unit.

This method offers two major advantages:

- Presets modified by the user will not be overwritten when reinstalling or updating the driver
- The factory presets remain unchanged, and can be reloaded any time.

Mouse: The original factory presets can be reloaded by holding down the Ctrl-key and clicking on any preset button. Alternatively the files described above can be renamed, moved to a different directory, or being deleted.

Keyboard: Using Ctrl and any number between 1 and 8 (not on the numeric keypad!) will load the corresponding factory default preset. The key Alt will load the user presets instead.



When loading a preset file, for example 'Main Monitor AN 1_2 plus headphone mix 3_4.mix', the file name will be displayed in the title bar of the TotalMix window. Also when loading a preset by the preset buttons, the name of the preset is displayed in the title bar. This way it is always clear what the current TotalMix state is based on.

The eight factory presets offer a pretty good base to modify them to your personal needs. In all factory presets Submix View is active by default.

Preset 1

Description: All channels routed 1:1, monitoring of all playback channels via Phones.

Details: All inputs maximum attenuation. All playback channels 0 dB, routed to the same output. All outputs 0 dB, Phones -6 dB. Submix of all playbacks to the analog Phones output. Level display set to RMS +3 dB. View Submix active.

Note: This preset is *Default*, offering the standard functionality of a I/O-card.

Preset 2

Description: All channels routed 1:1, input and playback monitoring via Phones. As Preset 1, plus submix of all inputs (0 dB) on Phones.

Preset 3

Description: All channels routed 1:1, input and playback monitoring via Phones and outputs. As Preset 2, but all inputs set to 0 dB (1:1 pass through).

Preset 4

Description: All channels 1:1, playback monitoring via Phones and outputs. As Preset 3, but all inputs muted.

Preset 5

Description: All faders m.a. As Preset 1, but all outputs maximum attenuation, only Phones monitor of the playbacks is active.

Preset 6

Description: Submix on SPDIF at -6 dB. As Preset 1, plus submix of all playbacks on SPDIF.

Preset 7

Description: Submix on SPDIF at -6 dB. As Preset 6, but submix of all inputs and outputs on SPDIF (SPDIF Monitoring).

Preset 8

Description: Panic. As Preset 4, but playback channels muted too (no output signal).

Preset Banks

Instead of a single preset, all eight presets can be stored and loaded at once. This is done via Menu **File**, **Save All Presets as** and **Open All Presets** (file suffix .mpr). After the loading the presets can be activated by the preset buttons. In case the presets have been renamed (see chapter 28.11), these names will be stored and loaded too.

28.9 The Monitor Panel

The Monitor panel provides several options usually found on analog mixing desks. It offers quick access to monitoring functions which are needed all the time in typical studio work.

Monitor Main

Use the drop down menu to select the hardware outputs where your main monitors are connected to.

Dim

A click on this button will lower the volume of your main monitor output (see above) by an amount set up in the Preferences dialog (see below). This is the same as moving the third row faders down a bit, but much more convenient, as the old setting is back by a simple mouse click.

Mono

Sets the stereo output defined above to monaural playback. Useful to check for mono compatibility and phase problems.

Talkback

A click on this button will dim the Main Monitor output (see above) by an amount set up in the Preferences dialog. At the same time the control room's microphone signal (source defined in Preferences) is sent to the three destinations described below as *Monitor Phones*. The mic level is adjusted with the channel's input fader.



Monitor Phones 1/2/3

Use the drop down menu to select the hardware outputs where the submixes are sent to. These submixes are usually phones mixdowns for the musicians. A click on the button allows to hear the specific submix via the Main Monitor outputs. So when setting up or modifying the submix for the musician this process can be monitored easily and any time. Or in other words: you can easily check other hardware outputs/submixes by using the Monitor Phones function, without the need to copy/paste routings back and forth, or to reconfigure the cabling at the hardware.

28.10 Preferences

The dialog box Preferences is available via the menu *Options* or directly via F3.

Talkback

Input: Select the input channel of the Talkback signal (microphone in control room).

Dim: Amount of attenuation of the Main Monitor output in dB.

Listenback

Input: Select the input channel of the Listenback signal (microphone in recording room).

Dim: Amount of attenuation of the Monitor Phones outputs in dB.

Note: The Mute button of the Talkback and Listenback channel is still active. Therefore it is not necessary to select <NONE>, in case one of both shall be deactivated.

MIDI Controller, Full LC Display Support

See chapter 31.3 for details.

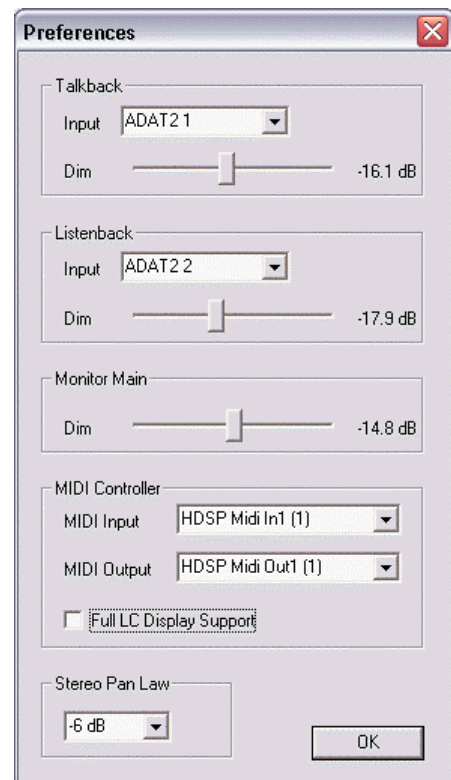

Main Monitor

Dim: Amount of attenuation of the Main Monitor output in dB. Activated by the *Dim* button in the Monitor panel.

Stereo Pan Law

The Pan Law can be set to -6 dB, -4.5 dB, -3 dB and 0 dB. The value chosen defines the level attenuation in pan center position. This setting is useful because the ASIO host often supports different pan laws too. Selecting the same value here and in the ASIO host, ASIO Direct Monitoring works perfectly, as both ASIO host and TotalMix use the same pan law. Of course, when not using ADM it can be changed to a setting different from the factory preset of -6 dB as well. You will most probably find that -3 dB gives a much more stable loudness when moving an object between left and right.

28.11 Editing the Names

The channel names shown in the white label area can be edited. A right mouse click on the white name field brings up the dialog box **Enter Name**. Any name can be entered in this dialog. Enter/Return closes the dialog box, the white label now shows the first letters of the new name. ESC cancels the process and closes the dialog box.



Moving the mouse above the label brings up a tool tip with the complete name.

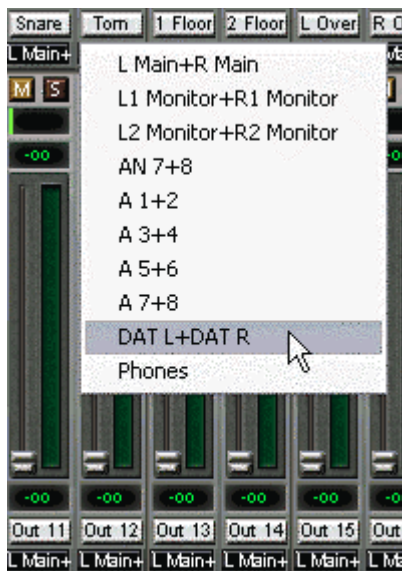

The hardware outputs (third row) can be edited in the same way. In this case, the names in the routing drop down menus will change automatically. Additionally the names in the drop down menus of the Monitor section will change as well.

The preset buttons can get meaningful names in the same way. Move the mouse above a preset button, a right mouse click will bring up the dialog box. Note that the name shows up as tool tip only, as soon as the mouse stays above the preset button.



The preset button names are not stored in the preset files, but globally in the registry, so won't change when loading any file or saving any state as preset. But loading a preset bank (see chapter 28.8) the names will be updated.

28.12 Hotkeys

In many situations TotalMix can be controlled quickly and comfortably by the keyboard, making the mixer setup considerably easier and faster. The **Shift**-key for the fine mode for faders and panpots has already been mentioned. The **Ctrl**-key can do far more than changing the routing pairwise:

- Clicking anywhere into the fader area with the Ctrl-key pressed, sets the fader to 0 dB.
- Clicking anywhere into the pan area with the Ctrl-key pressed, sets the panorama to <C> meaning Center.
- Clicking a preset button while holding down Ctrl, the original factory preset will be loaded.
- Using Ctrl and any number between 1 and 8 (not on the numeric keypad!) will load the corresponding factory default preset. Alt plus number loads the user preset.
- Using multiple Digifaces, clicking the button *Unit 2* while holding down Ctrl opens a second TotalMix window for the second HDSP system, instead of replacing the window contents.

The faders can also be moved pairwise, corresponding to the stereo-routing settings. This is achieved by pressing the **Alt**-key and is especially comfortable when setting the SPDIF and Phones output level. Even the panoramas can be operated with Alt, from stereo through mono to inversed channels, and also the Mute and Solo buttons (ganged or inversed switching!).

At the same time, TotalMix also supports combinations of these keys. If you press **Ctrl** and **Alt** at the same time, clicking with the mouse makes the faders jump to 0 dB pairwise, and they can be set pairwise by **Shift-Alt** in fine mode.

Also very useful: the faders have two mouse areas. The first area is the fader button, which can be grabbed at any place without changing the current position. This avoids unwanted changes when clicking onto it. The second area is the whole fader setting area. Clicking into this area makes the fader jump to the mouse at once. If for instance you want to set several faders to m.a., it is sufficient to click onto the lower end of the fader path. Which happens pairwise with the Alt-key pressed.

Using the hotkeys **I**, **O** and **P** the complete row of Input, Playback and Output channels each can be toggled between visible and invisible. Hotkey **S** switches Submix view on/off. Those four hotkeys have the same functionality as the buttons in the **View** section of the Quick Access Panel. The Level Meter Setup dialog can be opened via **F2** (as in DIGICheck). The dialog box Preferences is opened via **F3**.

Hotkey **M** toggles Mute Master on/off (and with this performs a global mute on/off). Hotkey **X** toggles the Matrix view on/off (see chapter 29), hotkey **T** the mixer view. Hotkey **L** links all faders as stereo pairs.

Further hotkeys are available to control the configuration of the Level Meter (see chapter 28.14):

- Key **4** or **6**: Display range 40 or 60 dB
- Key **E** or **R**: Numerical display showing Peak or RMS
- Key **0** or **3**: RMS display absolute or relative to 0 dBFS

28.13 Menu Options

Always on Top: When active (checked) the TotalMix window will always be on top of the Windows desktop.

Note: This function may result in problems with windows containing help text, as the TotalMix window will even be on top of those windows, so the help text isn't readable.

Deactivate Screensaver: When active (checked) any activated Windows screensaver will be disabled temporarily.

Ignore Position: When active, the windows size and position stored in a file or preset will not be used. The routing will be activated, but the window will not change.

ASIO Direct Monitoring (Windows only): When de-activated any ADM commands will be ignored by TotalMix. In other words, ASIO Direct Monitoring is globally de-activated.

Link Faders: Selecting this option all faders will be treated as stereo pairs and moved pairwise. Hotkey L.

Level Meter Setup: Configuration of the Level Meters. Hotkey F2. See chapter 28.14.

Preferences: Opens a dialog box to configure several functions, like Pan Law, Dim, Talkback Dim, Listenback Dim. See chapter 28.10.

Enable MIDI Control: Turns MIDI control on. The channels which are currently under MIDI control are indicated by a colour change of the info field below the faders, black turns to yellow.

Deactivate MIDI in Background: Disables the MIDI control as soon as another application is in the focus, or in case TotalMix has been minimized.

28.14 Level Meter

The Digiface calculates all the display values Peak, Over and RMS in hardware, in order to be capable of using them independent of the software in use, and to significantly reduce the CPU load.

Tip: This feature, the **Hardware Level Meter**, is used by **DIGICheck** (Windows only, see chapter 16) to display Peak/RMS level meters off all channels, nearly without any CPU load.

The level meters integrated in TotalMix - considering their size - cannot be compared with DIGICheck. Nevertheless they already include many useful functions.

Peak and RMS is displayed for every channel. 'Level Meter Setup' (menu Options or F2) and direct keyboard entry (*hotkeys*) make various options available:

- Display range 40 or 60 dB (*hotkey 4 or 6*)
- Release time of the Peak display (Fast/Medium/Slow)
- Numerical display selectable either Peak or RMS (*Hotkey E or R*)
- Number of consecutive samples for Overload display (1 to 15)
- RMS display absolute or relative to 0 dBFS (*Hotkey 3 or 0*)

The latter is a point often overlooked, but nonetheless important. A RMS measurement shows 3 dB less for sine signals. While this is mathematically correct, it is not very reasonable for a level meter. Therefore the RMS readout is usually corrected by 3 dB, so that a full scale sine signal shows 0 dBFS on both Peak and RMS meters. This setting also yields directly readable signal-to-noise values. Otherwise the value shown with noise is 3 dB better than it actually is (because the reference is not 0 dB, but -3 dB). For example in WaveLab.

The value displayed in the text field is independent of the setting 40/60 dB, it represents the full 24 bit range of the RMS measurement, thus making possible a SNR measurement 'RMS unweighted', which you would otherwise need extremely expensive measurement devices for. An example: An *RME ADI-8 DS* connected to the Digiface's ADAT port will show around -113 dBFS on all eight channel's input level meters.



This level display will constantly bring the reduced dynamic range of your equipment, maybe of the whole studio, in front of your eyes. Nice to have everything 24 bit - but still noise and hum everywhere in the range around -90 dB or worse... sorry, but this is the disappointing reality. The up-side about it is that TotalMix allows for constantly monitoring the signal quality without effort. Thus it can be a valuable tool for sound optimization and error removal in the studio.



Measuring SNR (Signal to Noise) requires to press R (for RMS) and 0 (for referring to 0 dBFS, a full scale signal). The text display will then show the same value as an expensive measurement system, when measuring 'RMS unweighted'.

Note: There is no RMS calculation for the third row, the physical outputs. Therefore the green bars show the peak value only.

29. TotalMix: The Matrix

29.1 Overview

The mixer window of TotalMix looks and operates similar to mixing desks, as it is based on a conventional stereo design. The matrix display presents a different method of assigning and routing channels, based on a single channel or monaural design. The matrix view of the HDSP looks and works like a conventional patchbay, adding functionality way beyond comparable hardware and software solutions. While most patchbays will allow you to connect inputs to outputs with just the original level (1:1, or 0 dB, as known from mechanical patchbays), TotalMix allows you to use a freely definable gain value per crosspoint.

Matrix and TotalMix are different ways of displaying the same processes. Because of this both views are always fully synchronized. Each change in one view is immediately reflected in the other view as well.

29.2 Elements of the Matrix View

The visual design of the TotalMix Matrix is mainly determined by the architecture of the HDSP system:

- Horizontal labels: All hardware outputs
- Vertical labels: All hardware inputs. Below are all playback channels (software playback channels)
- Green 0.0 dB field: Standard 1:1 routing
- Black gain field: Shows the current gain value as dB
- Orange gain field: This routing is muted.

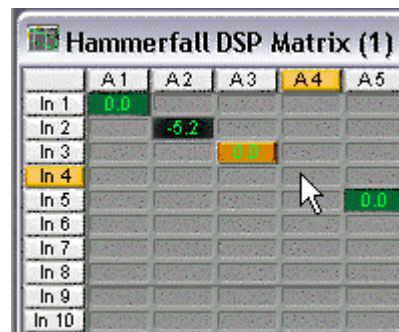

To maintain overview when the window size has been reduced, the left and upper labels are floating. They won't leave the visible area when scrolling.

29.3 Operation

Using the Matrix is a breeze. It is very easy to identify the current crosspoint, because the outer labels light up in orange according to the mouse position.

If input 1 is to be routed to output 1, use the mouse and click one time on crosspoint **In 1 / A 1**. The green 0.0 dB field pops in, another click removes it. To change the gain (equals the use of a different fader position, see simultaneous display of the mixer view), hold Ctrl down and drag the mouse up or down, starting from the gain field. The value within the field changes accordingly. The corresponding fader in the mixer view is moving simultaneously, in case the currently modified routing is visible.

Note the difference between the left side, representing the inputs and software playback channels, and the upper side, representing the hardware outputs. Moving a fader in row 1 or 2 in TotalMix view, only the specific levels (max. 2) of this routing will change within the Matrix. But moving a fader in row 3 will make all vertically activated levels move at once (for example 27/28, Phones output).

A gain field marked orange indicates activated mute status. Mute can only be changed in the mixer view.

29.4 Advantages of the Matrix

The Matrix not always replaces the mixer view, but it significantly enhances the routing capabilities and - more important - is a brilliant way to get a fast overview of all active routings. It shows you in a glance what's going on. And since the Matrix operates monaural, it is very easy to set up specific routings with specific gains.

Example 1: You want TotalMix to route all software outputs to all corresponding hardware outputs, and have a submix of all inputs and software outputs on the Phones output (equals factory preset 2). Setting up such a submix is easy. But how to check at a later time, that all settings are still exactly the way you wanted them to be, not sending audio to a different output?

The most effective method to check a routing in mixer view is the Submix View, stepping through all existing software outputs, and having a very concentrated look at the faders and displayed levels of each routing. That doesn't sound comfortably nor error-free, right? Here is where the Matrix shines. In the Matrix view, you simply see a line from upper left to lower right, all fields marked as unity gain. Plus two rows vertically all at the same level setting. You just need 2 seconds to be sure no unwanted routing is active anywhere, and that all levels match precisely!

Example 2: The Matrix allows you to set up routings which would be nearly impossible to achieve by fiddling around with level and pan. Let's say you want to send input 1 to output 1 at 0 dB, to output 2 at -3 dB, to output 3 at -6 dB and to output 4 at -9 dB. Each time you set up the right channel (2/4), the change in pan destroys the gain setting of the left channel (1/2). A real hassle! In Matrix view, you simply click on the corresponding routing point, set the level via Ctrl-mouse, and move on. You can see in TotalMix view how pan changes to achieve this special gain and routing when performing the second (fourth...) setting.

30. TotalMix Super-Features

30.1 ASIO Direct Monitoring (Windows only)

Start Samplitude, Sequoia, Cubase or Nuendo and TotalMix. Activate ADM (ASIO Direct Monitoring), and move a fader in the ASIO host. Now watch the corresponding fader in TotalMix magically move too. TotalMix reflects all ADM gain and pan changes in realtime. Please note that faders only move when the currently activated routing (currently visible routing) corresponds to the one in the ASIO host. Also note that the Matrix will show any change, as it shows all possible routings in one view.

With this TotalMix has become a wonderful debugging tool for ADM. Just move the host's fader and pan, and see what kind of ADM commands TotalMix receives.

The hardware output row faders are included in all gain calculations, in every possible way. Example: you have lowered the output level of a submix, or just a specific channel, by some dB. The audio signal passed through via ADM will be attenuated by the value set in the third row.

Tip: ASIO Direct Monitoring is not possible with the headphones output, because it is a mixer output only, not showing up in the ASIO host. But the Monitor Panel offers a simple work-around. Select the Phones output as *Monitor Main*, and the main mix output (for example A1 1+2) as *Monitor Phones*. When *Monitor Phones* is activated, the main mix is sent out of the headphone output – and with it all signals passed through by ADM.

30.2 Selection and Group-based Operation

Click on the white name label of channel 1 and 2 in TotalMix. Be sure to have channel 3's fader set to a different position and click on its label too. All three labels have changed to the colour orange, which means they are *selected*. Now moving any of these faders will make the other faders move too. This is called 'building a group of faders', or ganging faders, maintaining their relative position.

Building groups or ganging can be done in any row, but is limited to operate horizontally within one row. If you usually don't need this, you can at least gang the analog outputs. The advantage over holding the Alt-key is that Alt sets both channels to the same level (can be handy too), while grouping via selection will retain any offset (if you need one channel to be louder all the time etc.).

Note: The relative positions are memorized until the faders are pulled down so that they reach upper or lower maximum position *and* the group is changed (select another channel or deselect one of the group).

Tip: Gang some submixes and watch all routing levels change in the Matrix view.

30.3 Copy Routings to other Channels

TotalMix allows to copy complete routing schemes of inputs and outputs.

Example 1: You have input 1 (guitar) routed within several submixes/hardware outputs (= headphones). Now you'll get another input with keyboards that should appear in the same way on all headphones. Select input 1, open the menu *Edit*. It shows 'Copy In 1'. Now select the desired new input, for example In 8. The menu now shows 'Paste In 1 to In 8'. Click on it - done. If you are familiar with this functionality just use Ctrl-C and Ctrl-V. Else the self updating menu will always let you know what actually will happen.

Tip: Have the Matrix window open as second window when doing this. It will show the new routings immediately, so copying is easier to understand and to follow.

Example 2: You have built a comprehensive submix on outputs 4/5, but now need the exact same signal also on the outputs 6/7. Click on Out 4, Ctrl-C, click on Out 6, Ctrl-V, same with 5/7 - you're done!

The Matrix shows you the difference between both examples. Example 1 means copying lines (horizontally), while example 2 means copying rows (vertically).

Example 3: Let's say the guitarist finished his recording, and you now need the same signal again on all headphones, but this time it comes from the recording software (playback row). No problem, you can even copy between rows 1 and 2 (copying between row 3 and 1/2 isn't possible).

But how to select while a group is active? De-selecting the group first? Not necessary! TotalMix always updates the copy and paste process with the *last* selection. This way you don't have to de-activate any group-selections when desiring to perform a copy and paste action.

30.4 Delete Routings

The fastest way to delete complex routings: select a channel in the mixer view, click on the menu entry *Edit* and select *Delete*. Or simply hit the Del-key. Attention: there is no undo in TotalMix, so be careful with this function!

30.5 Recording a Subgroup (Loopback)

TotalMix supports a routing of the subgroup outputs (=hardware outputs, bottom row) to the recording software. Instead of the signal at the hardware input, the signal at the hardware output is sent to the record software. This way, complete submixes can be recorded without an external loopback cable. Also the playback of a software can be recorded by another software.

To activate this function, click on the white label in the third row while holding down the Ctrl-key. The label's colour changes to red. In case the channel has already been part of a group, the colour will change from yellow to orange, signalling that the group functionality is still active for this channel.

In loopback mode, the signal at the hardware input of the corresponding channel is no longer sent to the recording software, but still passed through to TotalMix*. Therefore TotalMix can be used to route this input signal to any hardware output. Using the subgroup recording, the input can still be recorded on a different channel.

* **Note:** Because of a technical limitation the input's level meter no longer shows the input signal of the hardware – which still can be routed by TotalMix – but the loopback signal. This gives the false impression of the loopback signal being present at the TotalMix mixer input, which is not the case.

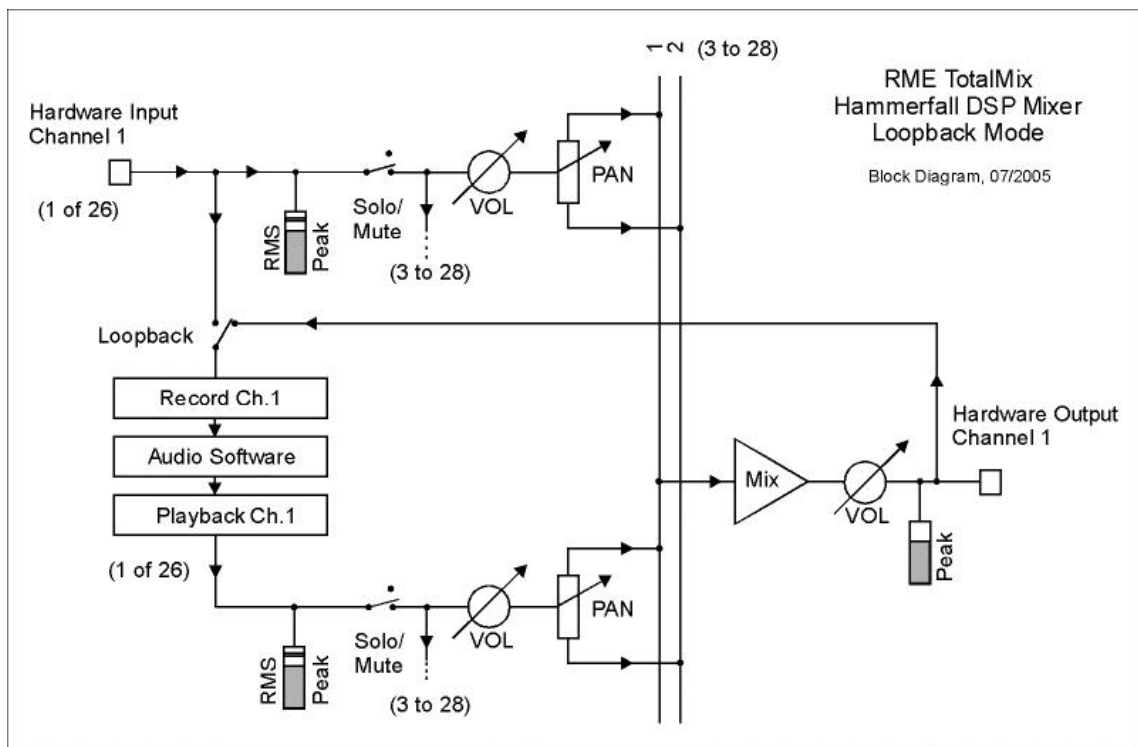

As each of the 26 hardware outputs can be routed to the record software, and none of these hardware inputs get lost, TotalMix offers an overall flexibility and performance not rivaled by any other solution.

Additionally the risk of feedbacks, a basic problem of loopback methods, is highly reduced, because the feedback can not happen within the mixer, but only when the audio software is switched into monitoring mode. The block diagram shows how the software's input signal is played back, and fed back from the hardware output to the software input. A software monitoring on the subgroup record channels is only allowed as long as the monitoring is routed in both software and TotalMix to a different channel than the active subgroup recording one.

Recording a Software's playback

In real world application, recording a software's output with another software will show the following problem: The record software tries to open the same playback channel as the playback software (already active), or the playback one has already opened the input channel which should be used by the record software.

This problem can easily be solved. First make sure that all rules for proper multi-client operation are met (not using the same record/playback channels in both programs). Then route the playback signal via TotalMix to a hardware output in the range of the record software, and activate it via Ctrl-mouse for recording.

Mixing several input signals into one record channel

In some cases it is useful to record several sources in only one track. For example when using two microphones when recording instruments and loudspeakers. TotalMix' Loopback mode saves an external mixing desk. Simply route/mix the input signals to the same output (third row), then re-define this output into a record channel via Ctrl-mouse – that's it. This way any number of input channels from different sources can be recorded into one single track.

30.6 Using external Effects Devices

With TotalMix a usage of external hardware - like effects devices - is easy and flexible.

Example 1: The singer (microphone input channel 1) shall have some reverb on his headphones (outputs 27/28). A direct routing In 1 to Out 27/28 for monitoring had been set up already. The external reverb is connected to a free output, for example channel 8. In active mode Submix View click on channel 8 in the bottom row. Drag the fader of input 1 to about 0 dB and the panorama fully to the right. Adjust the input level at the reverb unit to an optimal setting. Next the output of the reverb unit is connected to a free stereo input, for example 5/6. Use the TotalMix level meters to adjust a matching output level at the reverb unit. Now click on channels 27/28 in the bottom row, and move the fader of inputs 5/6 until the reverb effect gets a bit too loud in the headphones. Now click on channel 8 in the bottom row again and drag fader 1 down a bit until the mix of original signal and reverb is perfect for the singer.

The described procedure is completely identical to the one when using an analog mixing desk. There the signal of the singer is sent to an output (usually labeled Aux), from there to a reverb unit, sent back from the reverb unit as stereo wet signal (no original sound), back in through a stereo input (e.g. Effect return) and mixed to the monitoring signal. The only difference: The Aux sends on mixing desks are post-fader. Changing the level of the original signal causes a change of the effects level (here the reverb) too, so that both always have the same ratio.

Tip: Such a functionality is available in TotalMix via the right mouse button! Dragging the faders by use of the right mouse button causes all routings of the current input or playback channel to be changed in a relative way. This completely equals the function Aux post fader.

Example 2: Inserting an effects device can be done as above, even within the record path. Other than in the example above the reverb unit also sends the original signal, and there is no routing of input 1 directly to outputs 27/28. To insert an effects device like a Compressor/Limiter directly into the record path, the input signal of channel 1 is sent by TotalMix to any output, to the Compressor, back from the Compressor to any input. This input is now selected within the record software.

Unfortunately, very often it is not possible within the record software to assign a different input channel to an existing track 'on the fly'. The loopback mode solves this problem elegantly. The routing scheme stays the same, with the input channel 1 sent to any output via TotalMix, to the Compressor, from the Compressor back to any input. Now this input signal is routed directly to output 1, and output 1 is then switched into loopback mode via Ctrl-mouse.

As explained in chapter 30.5, the hardware input of channel 1 now no longer feeds the record software, but is still connected to TotalMix (and thus to the Compressor). The record software receives the signal of submix channel 1 instead – the Compressor's return path.

31. TotalMix MIDI Remote Control

31.1 Overview

TotalMix can be remote controlled via MIDI. It is compatible to the widely spread Mackie Control protocol, so TotalMix can be controlled with all hardware controllers supporting this standard. Examples are the Mackie Control, Tascam US-2400 or Behringer BCF 2000.

Additionally, the stereo output faders (lowest row) which are set up as *Monitor Main* outputs in the Monitor panel can also be controlled by the standard **Control Change Volume** via **MIDI channel 1**. With this, the main volume of the Digiface is controllable from nearly any MIDI equipped hardware device.

31.2 Setup

- Open the Preferences dialog (menu Options or F3). Select the MIDI Input and MIDI Output port where your controller is connected to.
- When no feedback is needed (when using only standard MIDI commands instead of Mackie Control protocol) select NONE as MIDI Output.
- Check *Enable MIDI Control* in the Options menu.

31.3 Operation

The channels being under MIDI control are indicated by a colour change of the info field below the faders, black turns to yellow.

The 8-fader block can be moved horizontally and vertically, in steps of one or eight channels.

Faders can be selected to gang them.

In Submix View mode, the current routing destination (output bus) can be selected via REC Ch. 1 – 8. This equals the selection of a different output channel in the lowest row by a mouse click when in Submix View. In MIDI operation it is not necessary to jump to the lowest row to perform this selection. This way even the routing can be easily changed via MIDI.

Full LC Display Support: This option in Preferences (F3) activates complete Mackie Control LCD support with eight channel names and eight volume/pan values.



Attention: this feature causes heavy overload of the MIDI port when ganging more than 2 faders! In such a case, or when using the Behringer BCF2000, turn off this option.

When *Full LC Display Support* is turned off, only a brief information about the first fader of the block (channel and row) is sent. This brief information is also available on the LED display of the Behringer BCF2000.

Tip for Mac OS X users: LC Xview (www.opuslocus.com) provides an on-screen display emulating the hardware displays of a Logic/Mackie Control, for use with controllers that can emulate a Logic/Mackie Control but do not have a display. Examples include the Behringer BCF2000 and Edirol PCR-series.

Deactivate MIDI in Background (menu Options) disables the MIDI control as soon as another application is in the focus, or in case TotalMix has been minimized. This way the hardware controller will control the main DAW application only, except when TotalMix is in the foreground. Often the DAW application can be set to become inactive in background too, so that MIDI control is switched between TotalMix and the application automatically when switching between both applications.

TotalMix also supports the 9th fader of the Mackie Control. This fader (labeled Master) will control the stereo output faders (lowest row) which are set up as *Main Monitor* outputs in the Monitor panel. Always and only.

31.4 Mapping

TotalMix supports the following Mackie Control surface elements*:

Element:	Meaning in TotalMix:
Channel faders 1 – 8	volume
Master fader	Main Monitor channel's faders
SEL(1-8) + DYNAMICS	reset fader to Unity Gain
V-Pots 1 – 8	pan
pressing V-Pot knobs	pan = center
CHANNEL LEFT or REWIND	move one channel left
CHANNEL RIGHT or FAST FORWARD	move one channel right
BANK LEFT or ARROW LEFT	move eight channels left
BANK RIGHT or ARROW RIGHT	move eight channels right
ARROW UP or Assignable1/PAGE+	move one row up
ARROW DOWN or Assignable2/PAGE-	move one row down
EQ	Master Mute
PLUGINS/INSERT	Master Solo
STOP	Dim Main Monitor
PLAY	Talkback
PAN	Mono Main Monitor
MUTE Ch. 1 – 8	Mute
SOLO Ch. 1 – 8	Solo
SELECT Ch. 1 – 8	Select
REC Ch. 1 – 8	in Submix mode only: select output bus
F1 - F8	load preset 1 - 8
F9	select Main Monitor
F10 - F12	Monitor Phones 1 - 3

*Tested with Behringer BCF2000 Firmware v1.07 in Mackie Control emulation for Steinberg mode and with Mackie Control under Mac OS X.

31.5 Simple MIDI Control

The stereo output faders (lowest row) which are set up as *Monitor Main* outputs in the Monitor panel can also be controlled by the standard **Control Change Volume** via **MIDI channel 1**. With this, the main volume of the Digiface is controllable from nearly any MIDI equipped hardware device.

Even if you don't want to control all faders and pans, some buttons are highly desired to be available in 'hardware'. These are mainly the *Talkback* and the *Dim* button, and the new monitoring options (listen to Phones submixes). Fortunately a Mackie Control compatible controller is not required to control these buttons, as they are steered by simple Note On/Off commands on MIDI channel 1.

The notes are (hex / decimal / keys):

Monitor Main: 3E / 62 / **D 3**

Dim: 5D / 93 / **A 5**

Mono: 2A / 42 / **#F 1**

Talkback: 5E / 94 / **#A 5**

Monitor Phones 1: 3F / 63 / **#D 3**

Monitor Phones 2: 40 / 64 / **E 3**

Monitor Phones 3: 41 / 65 / **F 3**

Preset 1: 36 / 54 / **#F 2**

Preset 2: 37 / 55 / **G 2**

Preset 3: 38 / 56 / **#G 2**

Preset 4: 39 / 57 / **A 2**

Preset 5: 3A / 58 / **#A 2**

Preset 6: 3B / 59 / **B 2**

Preset 7: 3C / 60 / **C 3**

Preset 8: 3D / 61 / **#C 3**

An example of a small MIDI controller covering such MIDI functionality (and even some more) is the **Behringer BCN44**. This little box has 4 pots and 8 buttons for all the above functions – for less than 60 Euros.

31.6 Loopback Detection

The Mackie Control protocol requires feedback of the received commands, back to the hardware controller. So usually TotalMix will be set up with both a MIDI input and MIDI output. Unfortunately any small error in wiring and setup will cause a MIDI feedback loop here, which then completely blocks the computer (the CPU).

To prevent the computer from freezing, TotalMix sends a special MIDI note every 0.5 seconds to its MIDI output. As soon as it detects this special note at the input, the MIDI functionality is disabled. After fixing the loopback, check *Enable MIDI Control* under Options to reactivate the TotalMix MIDI.

User's Guide



Digiface

▶ **Technical Reference**

32. Tech Info

Not all information to and around our products fit in a manual. Therefore RME offers a lot more and detailed information in the **Tech Infos**. The very latest Tech Infos can be found on our website, section News & Infos, or the directory rmeaudio.webtechinfo on the RME Driver CD. These are some of the currently available *Tech Infos*:

Synchronization II (DIGI96 series)

Digital audio synchronization - technical background and pitfalls.

Installation problems - Problem descriptions and solutions.

Driver updates Hammerfall DSP – Lists all changes of the driver updates.

DIGICheck: Analysis, tests and measurements with RME audio hardware
A description of DIGICheck, including technical background information.

ADI-8 Inside

Technical information about the RME ADI-8 (24-bit AD/DA converter).

Many background information on laptops and tests of notebooks:

HDSP System: Notebook Basics - Notebook Hardware

HDSP System: Notebook Basics - The Audio Notebook in Practice

HDSP System: Notebook Basics - Background Knowledge and Tuning

HDSP System: Notebook Tests - Compatibility and Performance

The digital mixer of the Hammerfall DSP in theory and practise

HDSP System: TotalMix - Hardware and Technology

HDSP System: TotalMix - Software, features, operation

33. Technical Specifications

33.1 Analog

Stereo Monitor Output

- Maximum output level at 0 dBFS: +8 dBu
- Dynamic range: 108 dB (RMS unweighted, unmuted), 112 dBA
- THD+N: -100 dB / 0.001 %
- Channel separation: > 110 dB
- Frequency response DA, -0.1 dB: 20 Hz - 20.8 kHz (sf 44,1 kHz)
- Frequency response DA, -0.5 dB: 10 Hz - 44 kHz (sf 96 kHz)
- Output impedance: 75 Ohm

33.2 Digital

- Low Jitter Design: < 3 ns external clock, < 1 ns internal clock
- Internal sample rates: 32 / 44.1 / 48 / 88.2 / 96 kHz
- Supported sample rates through word clock: 28 kHz - 103 kHz
- Internal resolution: 24 bit
- Input PLL ensures zero dropout, even at more than 40 ns jitter
- Bitclock PLL for trouble-free varispeed ADAT operation
- Ground-free digital inputs and outputs

33.3 Digital Inputs

SPDIF - AES/EBU

- 1 x RCA, transformer-balanced, galvanically isolated, according to AES3-1992
- High-sensitivity input stage (< 0.3 Vpp)
- SPDIF compatible (IEC 60958)
- Accepts Consumer and Professional format, copy protection will be ignored
- Lock range: 28 kHz – 103 kHz
- Jitter when synced to input signal: < 3 ns

ADAT Optical

- 3 x TOSLINK, format according to Alesis specification
- Standard: 24 channels 24 bit, up to 48 kHz
- Double Speed (S/MUX): 12 channels 24 bit 96 kHz
- Bitclock PLL ensures perfect synchronisation even in varispeed operation
- Lock range: 31.5 kHz – 50 kHz
- Jitter when synced to input signal: < 3 ns

Word Clock

- BNC, not terminated (10 kOhm)
- Automatic Double Speed detection and internal conversion to Single Speed
- Not affected by DC-offsets within the network
- Overvoltage protection
- Level range: 1.0 Vpp – 5.6 Vpp
- Lock Range: 28 kHz – 103 kHz
- Jitter when synced to input signal: < 3 ns

33.4 Digital Outputs

SPDIF - AES/EBU

- 1 x RCA, transformer-balanced, galvanically isolated, according to AES3-1992
- Output level Professional 2.3 Vpp, Consumer 1.0 Vpp
- Format Professional according to AES3-1992 Amendment 4
- Format Consumer (SPDIF) according to IEC 60958
- Single Wire mode, sample rate 28 kHz up to 103 kHz

ADAT

- 3 x TOSLINK
- Standard: 24 channels 24 bit, up to 48 kHz
- Double Speed (S/MUX): 12 channels 24 bit 96 kHz

Word Clock

- BNC, max. output voltage: 5 Vpp
- Output voltage @ 75 Ohm termination: 4.0 Vpp
- Output impedance: 10 Ohm
- Frequency range: 27 kHz – 103 kHz

33.5 MIDI

- 2 x MIDI I/O via 5-pin DIN jacks
- Galvanically isolated by optocoupled input
- Hi-speed mode: Jitter and response time typically below 1 ms
- Separate 128 byte FIFOs for input and output

33.6 Transfer Modes: Resolution / Bits per Sample

ASIO

- 24 / 32 bit 4 byte (stereo 8 byte)

This format is compatible with 16 bit and 20 bit. Resolutions below 24 bit are handled by the audio application.

MME

- 16 bit 2 byte (stereo 4 bytes)
- 16 bit 4 byte MSB (stereo 8 bytes)
- 24 bit 4 byte MSB (stereo 8 bytes)
- 32 bit 4 byte (stereo 8 bytes)

33.7 General

- Power supply: external switching power supply, 100 - 240 V AC, 15 Watt
- Current at 12 Volt operating voltage, unloaded: 200 mA (2.5 Watt)
- Current at 12 Volt operating voltage, loaded: 400 mA (4.8 Watt)
- Typical power consumption: 5 Watt
- Voltage range: DC 8 V – 28 V, AC 8 V – 20 V
- Dimensions (WxHxD): 215 x 44 x 115 mm (8.5" x 1.73" x 4.5")
- Weight: 1.5 kg (3.3 lbs)
- Temperature range: +5° up to +50° Celsius (41° F up to 122°F)
- Relative humidity: < 75%, non condensing

34. Technical Background

34.1 Lock and SyncCheck

Digital signals consist of a carrier and the data. If a digital signal is applied to an input, the receiver has to synchronize to the carrier clock in order to read the data correctly. To achieve this, the receiver uses a PLL (Phase Locked Loop). As soon as the receiver meets the exact frequency of the incoming signal, it is locked. This **Lock** state remains even with small changes of the frequency, because the PLL tracks the receiver's frequency.

If an ADAT or SPDIF signal is applied to the Digiface, the corresponding input LED starts flashing. The unit indicates LOCK, i. e. a valid input signal (in case the signal is also in sync, the LED is constantly lit, see below).

Unfortunately, LOCK does not necessarily mean that the received signal is correct with respect to the clock which processes the read out of the embedded data. Example [1]: The Digiface is set to 44.1 kHz internally (clock mode Master), and a mixing desk with ADAT output is connected to input ADAT1. The corresponding LED will show LOCK immediately, but usually the mixing desk's sample rate is generated internally (also Master), and thus slightly higher or lower than the Digiface's internal sample rate. Result: When reading out the data, there will frequently be read errors that cause clicks and drop outs.

Also when using multiple inputs, a simple LOCK is not sufficient. The above described problem can be solved elegantly by setting the Digiface from Master to AutoSync (its internal clock will then be the clock delivered by the mixing desk). But in case another un-synchronous device is connected, there will again be a slight difference in the sample rate, and therefore clicks and drop outs.

In order to display those problems optically at the device, the Digiface includes **SyncCheck**[®]. It checks all clocks used for *synchronicity*. If they are not synchronous to each other (i. e. absolutely identical), the SYNC LED of the asynchronous input flashes. In case they are completely synchronous, all LEDs are constantly lit. In example 1 it would have been obvious that the LED ADAT 1 kept on flashing after connecting the mixing desk.

In practice, SyncCheck allows for a quick overview of the correct configuration of all digital devices. So one of the most difficult and error-prone topics of the digital studio world finally becomes easy to handle.

The same information is presented in the Digiface's Settings dialog. In the status display *SyncCheck* the state of all clocks is decoded and shown as simple text (No Lock, Lock, Sync).

34.2 Latency and Monitoring

The term **Zero Latency Monitoring** has been introduced by RME in 1998 for the DIGI96 series of audio cards. It stands for the ability to pass-through the computer's input signal at the interface directly to the output. Since then, the idea behind has become one of the most important features of modern hard disk recording. In the year 2000, RME published two ground-breaking Tech Infos on the topics *Low Latency Background*, which are still up-to-date: *Monitoring, ZLM and ASIO*, and *Buffer and Latency Jitter*, both found on the RME Driver CD and the RME website.

How much Zero is Zero?

From a technical view there is no zero. Even the analog pass-through is subject to phase errors, equalling a delay between input and output. However, delays below certain values can subjectively be claimed to be a zero-latency. This applies to analog routing and mixing, and in our opinion also to RME's Zero Latency Monitoring. The term describes the digital path of the audio data from the input of the interface to its output. The digital receiver of the Digiface can't operate un-buffered, and together with TotalMix and the output via the transmitter, it causes a typical delay of 4 samples. At 44.1 kHz this equals about 90 μ s (0.000090 s). In Double Speed mode, the delay doubles to 8 samples, for both ADAT and SPDIF.

Oversampling

While the delays of digital interfaces can be disregarded altogether, the analog inputs and outputs do cause a significant delay. Modern converter chips operate with 64 or 128 times oversampling plus digital filtering, in order to move the error-prone analog filters away from the audible frequency range as far as possible. This typically generates a delay of one millisecond. A playback and re-record of the same signal via DA and AD (loopback) then causes an offset of the newly recorded track of up to 2 ms. The following table lists the delay caused by the DA-converter of the Digiface's headphone output:

Sample frequency kHz	44.1	48	88.2	96
DA (43.4 x 1/fs) ms	0.98	0.9		
DA (87.5 x 1/fs) ms			0.99	0.9

Buffer Size (Latency)

Windows: This option found in the Settings dialog defines the size of the buffers for the audio data used in ASIO and GSIF (see chapter 13 and 14).

Mac OS X: The buffer size is defined within the application. Only some do not offer any setting. For example iTunes is fixed to 512 samples.

General: A setting of 64 samples at 44.1 kHz causes a latency of 1.5 ms, for record and playback each. But when performing a digital loopback test no latency/offset can be detected. The reason is that the software naturally knows the size of the buffers, therefore is able to position the newly recorded data at a place equalling a latency-free system.

AD/DA Offset under ASIO and OS X: ASIO (Windows) and Core Audio (Mac OS X) allow for the signalling of an offset value to correct buffer independent delays, like AD- and DA-conversion or the Safety Buffer described below. An analog loopback test will then show no offset, because the application shifts the recorded data accordingly.

Because the Digiface is a completely digital interface, and the delays introduced by external AD/DA-converters are unknown to unit and driver, the drivers include the digital offset values (4 / 8 samples). Therefore the delays caused by external converters have to be taken care off in the record software, which usually means that the user has to enter specific offset values manually.

Note: Cubase and Nuendo display the latency values signalled from the driver separately for record and playback. These values equal nearly exactly the buffer size (for example 3 ms at 128 samples) on RME's digital interfaces.

Core Audios Safety Offset

Under OS X, every audio interface has to use a so called *safety offset*, otherwise Core Audio won't operate click-free. The Digiface uses a safety offset of 32 samples. This offset is signalled to the system, and the software can calculate and display the total latency of buffer size plus plus safety offset for the current sample rate.

34.3 DS - Double Speed

When activating the *Double Speed* mode the Digiface operates at double sample rate. The internal clock 44.1 kHz turns to 88.2 kHz, 48 kHz to 96 kHz. The internal resolution is still 24 bit.

Sample rates above 48 kHz were not always taken for granted, and are still not widely used because of the CD format (44.1 kHz) dominating everything. Before 1998 there were no receiver/transmitter circuits available that could receive or transmit more than 48 kHz. Therefore a work-around was used: instead of two channels, one AES line only carries one channel, whose odd and even samples are being distributed to the former left and right channels. By this, you get the double amount of data, i. e. also double sample rate. Of course in order to transmit a stereo signal two AES/EBU ports are necessary then.

This transmission mode is called *Double Wire* in the professional studio world, and is also known as *S/MUX* (abbreviation for *Sample Multiplexing*) in connection with the ADAT format. The AES3 specification uses the uncommon term *Single channel double sampling frequency mode*.

Not before February 1998, Crystal shipped the first 'single wire' receiver/transmitters that could also work with double sample rate. It was then possible to transmit two channels of 96 kHz data via one AES/EBU port.

But *Double Wire* is still far from being dead. On one hand, there are still many devices which can't handle more than 48 kHz, e. g. digital tape recorders. But also other common interfaces like ADAT or TDIF are still using this technique.

Because the ADAT interface does not allow for sampling frequencies above 48 kHz (a limitation of the interface hardware), the Digiface automatically uses the *Sample Multiplexing* method in DS mode. One channel's data is distributed to two channels according to the following table:

ADAT Ch.	1	2	3	4	5	6	7	8
DS Channel	1	1	2	2	3	3	4	4
Samples	1a	1b	2a	2b	3a	3b	4a	4b

As the transmission of double rate signals is done at standard sample rate (Single Speed), the ADAT outputs still deliver 44.1 kHz or 48 kHz.

34.4 AES/EBU - SPDIF

The most important electrical properties of 'AES' and 'SPDIF' can be seen in the table below. AES/EBU is the professional balanced connection using XLR plugs. The standard is being set by the *Audio Engineering Society* based on the AES3-1992. For the 'home user', SONY and Philips have omitted the balanced connection and use either Phono plugs or optical cables (TOSLINK). The format called S/P-DIF (SONY/Philips Digital Interface) is described by IEC 60958.

Type	AES3-1992	IEC 60958
Connection	XLR	RCA / Optical
Mode	Balanced	Un-balanced
Impedance	110 Ohm	75 Ohm
Level	0.2 V up to 5 V _{ss}	0.2 V up to 0.5 V _{ss}
Clock accuracy	not specified	I: ± 50ppm II: 0,1% III: Variable Pitch
Jitter	< 0.025 UI (4.4 ns @ 44.1 kHz)	not specified

Besides the electrical differences, both formats also have a slightly different setup. The two formats are compatible in principle, because the audio information is stored in the same place in the data stream. However, there are blocks of additional information, which are different for both standards. In the table, the meaning of the first byte (#0) is shown for both formats. The first bit already determines whether the following bits should be read as Professional or Consumer information.

Byte	Mode	Bit 0	1	2	3	4	5	6	7
0	Pro	P/C	Audio?		Emphasis		Locked	Sample Freq.	
0	Con	P/C	Audio?	Copy	Emphasis			Mode	

It becomes obvious that the meaning of the following bits differs quite substantially between the two formats. If a device like a common DAT recorder only has an SPDIF input, it usually understands only this format. In most cases, it will switch off when being fed Professional-coded data. The table shows that a Professional-coded signal would lead to malfunctions for copy prohibition and emphasis, if being read as Consumer-coded data.

Nowadays many devices with SPDIF input can handle Professional subcode. Devices with AES3 input almost always accept Consumer SPDIF (passive cable adapter necessary).

35. Block Diagram Digiface

